

**DAIKIN**

Si30 - 701\_A

# Pocket Manual

## Service Diagnosis

**VRV**

Большая библиотека технической документации

<https://splitsystema48.ru/instrukcii-po-ekspluatacii-kondicionerov/>

каталоги, инструкции, сервисные мануалы, схемы.



Applicable Models .....	2
1. Symptom-based Troubleshooting .....	12
2. Troubleshooting by Remote Controller .....	18
2.1 The INSPECTION / TEST Button .....	18
2.2 Self-diagnosis by Wired Remote Controller .....	19
2.3 Self-diagnosis by Wireless Remote Controller .....	22
2.4 Error Codes and Description .....	24
2.5 Error Codes - Sub Codes .....	35
3. Troubleshooting by Indication on the Remote Controller .....	46
3.1 External Protection Device Abnormality .....	46
3.2 PCB Abnormality .....	48
3.3 Drain Level Control System (S1L) Abnormality .....	49
3.4 Fan Motor (M1F) Lock, Overload .....	52
3.5 Indoor Unit Fan Motor Abnormality .....	55
3.6 Overload/Overcurrent/ Lock of Indoor Unit Fan Motor .....	57
3.7 Swing Flap Motor (M1S) Abnormality .....	63
3.8 Power Supply Voltage Abnormality .....	66
3.9 Electronic Expansion Valve Coil Abnormality / Dust Clogging .....	68
3.10 Drain Level above Limit .....	71
3.11 Capacity Determination Device Abnormality .....	73
3.12 Transmission Error (between Indoor unit PCB and Fan PCB) .....	75
3.13 Thermistor for Liquid Pipe Abnormality .....	78
3.14 Thermistor for Gas Pipe Abnormality .....	80
3.15 Combination Abnormality (between Indoor unit PCB and Fan PCB) .....	82

3.17	Ⓔ Thermistor for Discharge Air Abnormality .....	86
3.18	Ⓕ Humidity Sensor System Abnormality .....	88
3.19	Ⓖ Room Temperature Thermistor in Remote Controller Abnormality .....	90
3.20	Ⓗ PCB Abnormality .....	92
3.21	Ⓘ Earth Leakage by Leak Detection PCB Assy .....	94
3.22	Ⓚ Actuation of High Pressure Sensor .....	97
3.23	Ⓛ Abnormal Discharge Pressure .....	99
3.24	Ⓜ Actuation of Low Pressure Sensor .....	102
3.25	Ⓨ Abnormal Suction Pressure .....	104
3.26	Ⓩ Inverter Compressor Motor Lock .....	107
3.27	ⓐ STD Compressor Motor Overcurrent/ Lock .....	115
3.28	ⓑ Outdoor Unit Fan Motor Abnormality .....	117
3.29	ⓓ Electronic Expansion Valve Coil Abnormality .....	130
3.30	ⓕ Abnormal Discharge Pipe Temperature .....	136
3.31	ⓗ Refrigerant Overcharged .....	143
3.32	ⓑ High Pressure Switch System Abnormality .....	148
3.33	ⓓ Outdoor Unit Fan Motor Signal Abnormality .....	150
3.34	ⓕ Outdoor Air Thermistor Abnormality .....	155
3.35	ⓗ Water System Error .....	159
3.36	ⓑ High Pressure Sensor Abnormality .....	162
3.37	ⓓ Current Sensor Abnormality .....	165
3.38	ⓕ Discharge Pipe Thermistor Abnormality .....	168
3.39	ⓗ Heat Exchanger Gas Pipe Thermistor Abnormality .....	170
3.40	ⓑ Suction Pipe Thermistor Abnormality .....	172
3.41	ⓓ Outdoor Unit Heat Exchanger Thermistor Abnormality .....	174
3.42	ⓕ Liquid Pipe Thermistor Abnormality .....	176
3.43	ⓗ Thermistor System Abnormality .....	178
3.44	ⓑ Subcooling Heat Exchanger Gas Pipe Thermistor Abnormality .....	180

3.46	Ⓜ Discharge Pipe Pressure Sensor Abnormality .....	185
3.47	Ⓜ Low Pressure Sensor Abnormality .....	188
3.48	Ⓜ Suction Pipe Pressure Sensor Abnormality .....	191
3.49	Ⓜ Inverter PCB Abnormality .....	194
3.50	Ⓜ Inverter Radiation Fin Temperature Rise Abnormality .....	202
3.51	Ⓜ Momentary Overcurrent of Inverter Compressor .....	207
3.52	Ⓜ Momentary Overcurrent of Inverter Compressor .....	213
3.53	Ⓜ Inverter Compressor Startup Failure .....	219
3.54	Ⓜ Transmission Error between Inverter and Control PCB .....	226
3.55	Ⓜ Inverter Over-Ripple Protection .....	234
3.56	Ⓜ Inverter Radiation Fin Thermistor Abnormality .....	239
3.57	Ⓜ Field Setting Abnormality after Replacing Main PCB or Combination of PCB Abnormality .....	243
3.58	Ⓜ Refrigerant Shortage Alert .....	250
3.59	Ⓜ Reverse Phase, Open Phase .....	259
3.60	Ⓜ Power Supply Insufficient or Instantaneous Error .....	261
3.61	Ⓜ Check Operation is not Executed .....	283
3.62	Ⓜ Transmission Error between Indoor Units and Outdoor Units .....	285
3.63	Ⓜ Transmission Error between Remote Controller and Indoor Unit .....	298
3.64	Ⓜ Transmission Error (Across Outdoor Units) .....	300
3.65	Ⓜ Transmission Error between Main and Sub Remote Controllers .....	314
3.66	Ⓜ Transmission Error between Indoor and Outdoor Units in the Same System .....	316
3.67	Ⓜ Improper Combination of Indoor and Outdoor Units, Indoor Units and Remote Controller .....	321

---

3.68	⚡	Address Duplication of Centralized Remote Controller .....	335
3.69	⚡	Transmission Error between Centralized Remote Controller and Indoor Unit .....	336
3.70	⚡	System is not Set yet .....	341
3.71	⚡	System Abnormality, Refrigerant System Address Undefined .....	343

**Applicable Model Series**

Refrigerant	Type	Product	Series	Reference Page
R-22	Air Cooled	VRVII	Inverter M(A)	2
		VRVII-S		3
VRVII		4		
VRVII-S		5		
R-410A	Water Cooled	VRV-WII		6
	Air Cooled	VRVIII		7
		VRVIII-Q	9	
		VRVIII-S	10	
	Water Cooled	VRV-WIII	11	

# Applicable Models

## 1. R-22

### 1-1. VRV7 M(A) Series

Indoor Units		Model Name													Symbol															
Type		20L	25L	32L	40L	50L	63L	80L	100L	125L	150L	200L	250L	300L	350L	400L	450L	500L	550L	600L	650L	700L	750L	800L	850L	900L	950L	1000L	Symbol	
Ceiling Mounted Cassette Type (Double Flow)	FXC																													
Ceiling Mounted Cassette Type (Multi Flow)	FXF																													
Ceiling Mounted Cassette Corner Type	FXK																													
Slim Ceiling Mounted Duct Type	FXD-PVE	20P	25P	32P	-	-	-	-	-	-	-	-	-	-	-	-	-	-	-	-	-	-	-	-	-	-	-	-	VE	
	FXD-PVET	20P	25P	32P	-	-	-	-	-	-	-	-	-	-	-	-	-	-	-	-	-	-	-	-	-	-	-	-	VE	
	FXD-MVE	20M	25M	32M	40M	50M	63M	80M	100M	125M	150M	200M	250M	300M	350M	400M	450M	500M	550M	600M	650M	700M	750M	800M	850M	900M	950M	1000M	V1	
	FXD-MVET	20M	25M	32M	40M	50M	63M	80M	100M	125M	150M	200M	250M	300M	350M	400M	450M	500M	550M	600M	650M	700M	750M	800M	850M	900M	950M	1000M	V1	
Ceiling Mounted Low Silhouette Duct Type	FXYD	20KA	25KA	32KA	40KA	50KA	63KA	80KA	100KA	125KA	150KA	200KA	250KA	300KA	350KA	400KA	450KA	500KA	550KA	600KA	650KA	700KA	750KA	800KA	850KA	900KA	950KA	1000KA	V1	
Ceiling Mounted Built-in Type	FXS	20L	25L	32L	40L	50L	63L	80L	100L	125L	150L	200L	250L	300L	350L	400L	450L	500L	550L	600L	650L	700L	750L	800L	850L	900L	950L	1000L	V1	
Ceiling Mounted Built-in Type (Rear Suction)	FXYB	20K	25K	32K	40K	50K	63K	80K	100K	125K	150K	200K	250K	300K	350K	400K	450K	500K	550K	600K	650K	700K	750K	800K	850K	900K	950K	1000K	V1	
Ceiling Mounted Duct Type	FXM	-	-	-	40L	50L	63L	80L	100L	125L	150L	200L	250L	300L	350L	400L	450L	500L	550L	600L	650L	700L	750L	800L	850L	900L	950L	1000L	VE	
Ceiling Suspended Type	FXH	-	-	32L	-	-	63L	-	100L	-	-	-	-	-	-	-	-	-	-	-	-	-	-	-	-	-	-	-	VE	
Wall Mounted Type	FXA	20L	25L	32L	40L	50L	63L	80L	100L	125L	150L	200L	250L	300L	350L	400L	450L	500L	550L	600L	650L	700L	750L	800L	850L	900L	950L	1000L	VE	
Floor Standing Type	FXL	20L	25L	32L	40L	50L	63L	80L	100L	125L	150L	200L	250L	300L	350L	400L	450L	500L	550L	600L	650L	700L	750L	800L	850L	900L	950L	1000L	VE	
Concealed Floor Standing Type	FXN	20L	25L	32L	40L	50L	63L	80L	100L	125L	150L	200L	250L	300L	350L	400L	450L	500L	550L	600L	650L	700L	750L	800L	850L	900L	950L	1000L	VE	

Outdoor Units		Model Name													Symbol															
Type		5M(A)	8M(A)	10M(A)	12M(A)	14M(A)	16M(A)	18M(A)	20M(A)	22M(A)	24M(A)	26M(A)	28M(A)	30M(A)	32M(A)	34M(A)	36M(A)	38M(A)	40M(A)	42M(A)	44M(A)	46M(A)	48M(A)	50M(A)	52M(A)	54M(A)	56M(A)	58M(A)	60M(A)	Symbol
Heat Pump	RXY	5M(A)	8M(A)	10M(A)	12M(A)	14M(A)	16M(A)	18M(A)	20M(A)	22M(A)	24M(A)	26M(A)	28M(A)	30M(A)	32M(A)	34M(A)	36M(A)	38M(A)	40M(A)	42M(A)	44M(A)	46M(A)	48M(A)	50M(A)	52M(A)	54M(A)	56M(A)	58M(A)	60M(A)	Y1(E) YL(E) TL(E)
Cooling Only	RX	5M(A)	8M(A)	10M(A)	12M(A)	14M(A)	16M(A)	18M(A)	20M(A)	22M(A)	24M(A)	26M(A)	28M(A)	30M(A)	32M(A)	34M(A)	36M(A)	38M(A)	40M(A)	42M(A)	44M(A)	46M(A)	48M(A)	50M(A)	52M(A)	54M(A)	56M(A)	58M(A)	60M(A)	Y1

## 1-2. VRV7-S M Series

Type	Model Name														Symbol					
	20L	25L	32L	40L	50L	63L	80L	100L	125L	20L	25L	32L	40L	50L		63L	80L	100L	125L	
Ceiling Mounted Cassette Type (Double Flow)	FXC																			
Ceiling Mounted Cassette Type (Multi Flow)	FXF																			
Ceiling Mounted Cassette Corner Type	FXK																			
Slim Ceiling Mounted Duct Type	FXD	20M	25M	32M	40M	50M	63M													
Ceiling Mounted Low Silhouette Duct Type	FXYD	20KA	25KA	32KA	40KA	50KA	63KA													
Ceiling Mounted Built-in Type	FXS	20L	25L	32L	40L	50L	63L	80L	100L	125L										
Ceiling Mounted Built-in Type (Rear Suction)	FXYB	20K	25K	32K	40K	50K	63K	80K	100K	125K										
Ceiling Mounted Duct Type	FXM																			
Ceiling Suspended Type	FXH			32L			63L		100L											
Wall Mounted Type	FXA	20L	25L	32L	40L	50L	63L													
Floor Standing Type	FXL	20L	25L	32L	40L	50L	63L													
Concealed Floor Standing Type	FXN	20L	25L	32L	40L	50L	63L													

## ■ Outdoor Units

Type	Model Name			Symbol	
	4M	5M	6M		
Heat Pump	RXYM	4M	5M	6M	VM
Cooling Only	RXM	4M	5M	6M	VMT



## 2. R-410A

## 2-1. VRV7 M(A) Series

Indoor Units		Model Name													Symbol
		Type	20M	25M	32M	40M	50M	63M	80M	100M	125M	150M	200M	250M	
Ceiling Mounted Cassette Type (Double Flow)	FXCQ	20M	25M	32M	40M	50M	63M	80M	-	125M	-	-	-	-	
	FXFQ	-	25M	32M	40M	50M	63M	80M	100M	125M	-	-	-	-	
	FXKQ	-	25MA	32MA	40MA	-	63MA	-	-	-	-	-	-	-	
Slim Ceiling Mounted Duct Type	FXDQ-PVE	20P	25P	32P	-	-	-	-	-	-	-	-	-	-	
	FXDQ-PVET	20P	25P	32P	-	-	-	-	-	-	-	-	-	-	
	FXDQ-NAVE	20NA	25NA	32NA	40NA	50NA	63NA	-	-	-	-	-	-	-	
	FXDQ-NVET	20N	25N	32N	40N	50N	63N	-	-	-	-	-	-	-	
	FXSQ	20M	25M	32M	40M	50M	63M	80M	100M	125M	-	-	-	-	
	FXMQ	-	-	-	40MA	50MA	63MA	80MA	100MA	125MA	200MA	250MA	-	-	-
Ceiling Mounted Built-in Type	FXHQ	-	-	32MA	-	-	63MA	-	100MA	-	-	-	-	-	
	FXAQ	20MA	25MA	32MA	40MA	50MA	63MA	-	-	-	-	-	-	-	
Wall Mounted Type	FXLQ	20MA	25MA	32MA	40MA	50MA	63MA	-	-	-	-	-	-	-	
	FXNQ	20MA	25MA	32MA	40MA	50MA	63MA	-	-	-	-	-	-	-	
Concealed Floor Standing Type	FXUQ	-	-	-	-	-	-	-	-	-	-	-	-	-	
	BEVQ	-	-	-	-	-	-	71MA	100MA	125MA	-	-	-	V1	
Ceiling Suspended Cassette Type	BEVQ	-	-	-	-	-	-	71MA	100MA	125MA	-	-	-	VE	
	BEVQ	-	-	-	-	-	-	71MA	100MA	125MA	-	-	-	VE	

Outdoor Units		Model Name													Symbol									
		Type	5MA	8MA	10MA	12MA	14MA	16MA	18MA	20MA	22MA	24MA	26MA	28MA		30MA	32MA	34MA	36MA	38MA	40MA	42MA	44MA	46MA
Heat Pump	RXYQ	5MA	8MA	10MA	12MA	14MA	16MA	18MA	20MA	22MA	24MA	26MA	28MA	30MA	32MA	34MA	36MA	38MA	40MA	42MA	44MA	46MA	48MA	Y1(E)
		28MA	30MA	32MA	34MA	36MA	38MA	40MA	42MA	44MA	46MA	48MA	Y1(E)	TL(E)										
Cooling Only	RXQ	5MA	8MA	10MA	12MA	14MA	16MA	18MA	20MA	22MA	24MA	26MA	28MA	30MA	32MA	34MA	36MA	38MA	40MA	42MA	44MA	46MA	48MA	Y1
		8M	10M	12M	14M	16M	18M	20M	22M	24M	26M	28M	30M	32M	34M	36M	38M	40M	42M	44M	46M	48M	Y1B	
Heat Recovery	REYQ	8M	10M	12M	14M	16M	18M	20M	22M	24M	26M	28M	30M	32M	34M	36M	38M	40M	42M	44M	46M	48M	Y1B	
		30M	32M	34M	36M	38M	40M	42M	44M	46M	48M	Y1B												



## 2-3. VRV-WII M Series

Indoor Units	Type		Model Name										Symbol	
	Type	Model Name	20M	25M	32M	40M	50M	63M	80M	100M	125M	200M		250M
Indoor Units	Ceiling Mounted Cassette Type (Double Flow)	FXCQ	20M	25M	32M	40M	50M	63M	80M	-	125M	-	-	
	Ceiling Mounted Cassette Type (Multi Flow)	FXFQ	-	25M	32M	40M	50M	63M	80M	100M	125M	-	-	
	Ceiling Mounted Cassette Corner Type	FXKQ	-	25MA	32MA	40MA	-	63MA	-	-	-	-	-	
	Slim Ceiling Mounted Duct Type	FXDQ-PVE	20P	25P	32P	-	-	-	-	-	-	-	-	-
		FXDQ-PVET	20P	25P	32P	-	-	-	-	-	-	-	-	-
		FXDQ-NAVE	20NA	25NA	32NA	40NA	50NA	63NA	-	-	-	-	-	-
		FXDQ-NVET	20N	25N	32N	40N	50N	63N	-	-	-	-	-	-
	Ceiling Mounted Built-in Type	FXSQ	20M	25M	32M	40M	50M	63M	80M	100M	125M	-	-	
	Ceiling Mounted Duct Type	FXMQ	-	-	-	40MA	50MA	63MA	80MA	100MA	125MA	200MA	250MA	
	Ceiling Suspended Type	FXHQ	-	-	32MA	-	-	63MA	-	100MA	-	-	-	
Wall Mounted Type	FXAQ	20MA	25MA	32MA	40MA	50MA	63MA	-	-	-	-	-		
Floor Standing Type	FXLQ	20MA	25MA	32MA	40MA	50MA	63MA	-	-	-	-	-		
Concealed Floor Standing Type	FXNQ	20MA	25MA	32MA	40MA	50MA	63MA	-	-	-	-	-		
Ceiling Suspended Cassette Type	FXUQ	-	-	-	-	-	-	-	71MA	100MA	125MA	-		
Connection Unit	BEVQ	-	-	-	-	-	-	-	71MA	100MA	125MA	-		

### Outside Units

Type	Model Name		Symbol		
	10M	20M		30M	
Heat Pump	RWEYQ	10M	20M	30M	Y1 YL TL

## 2-4. VRV VIII P(A) Series

Type	Model Name													Symbol				
	-	25P	32P	40P	50P	63P	80P	100P	125P	-	-	-	-					
Ceiling Mounted Cassette Type (Round Flow)	FXFQ	-	-	-	-	-	-	-	-	-	-	-	-	-	-	-	-	-
Ceiling Mounted Cassette Type (Compact Multi Flow)	FXZQ	20M	32M	40M	50M	63M	80M	-	-	-	-	-	-	-	-	-	-	-
Ceiling Mounted Cassette Type (Double Flow)	FXCQ	20M	32M	40M	50M	63M	80M	-	-	-	-	-	-	-	-	-	-	-
Ceiling Mounted Cassette Corner Type	FXKQ	-	25MA	32MA	40MA	50MA	63MA	-	-	-	-	-	-	-	-	-	-	-
Slim Ceiling Mounted Duct Type	FXDQ-PBVE	20PB	25PB	32PB	-	-	-	-	-	-	-	-	-	-	-	-	-	-
	FXDQ-PBVE	20PB	25PB	32PB	-	-	-	-	-	-	-	-	-	-	-	-	-	-
	FXDQ-NBVE	-	-	-	40NB	50NB	63NB	-	-	-	-	-	-	-	-	-	-	-
	FXDQ-NBVE	-	-	-	40NB	50NB	63NB	-	-	-	-	-	-	-	-	-	-	-
Ceiling Mounted Built-in Type	FXSQ	20M	25M	32M	40M	50M	63M	80M	100MA	125M	-	-	-	-	-	-	-	-
Ceiling Mounted Duct Type (Middle and High Static Pressure)	FXMQ	20P	25P	32P	40P	50P	63P	80P	100P	125P	140P	-	-	-	-	-	-	-
Ceiling Mounted Duct Type	FXMQ	-	-	-	-	-	-	-	-	-	-	-	-	-	-	200MA	250MA	-
Ceiling Suspended Type	FXHQ	-	-	32MA	-	-	63MA	-	100MA	-	-	-	-	-	-	-	-	-
Wall Mounted Type	FXAQ	20MA	25MA	32MA	40MA	50MA	63MA	-	-	-	-	-	-	-	-	-	-	-
Floor Standing Type	FXLQ	20MA	25MA	32MA	40MA	50MA	63MA	-	-	-	-	-	-	-	-	-	-	-
Concealed Floor Standing Type	FXNQ	20MA	25MA	32MA	40MA	50MA	63MA	-	-	-	-	-	-	-	-	-	-	-
Ceiling Suspended Cassette Type	FXUQ	-	-	-	-	-	-	-	71MA	100MA	125MA	-	-	-	-	-	-	V1
Connection Unit	BEVQ	-	-	-	-	-	-	-	71MA	100MA	125MA	-	-	-	-	-	-	VE

## Outdoor Units

Type	Model Name														Symbol										
	5P(A)	8P(A)	10P(A)	12P(A)	14P(A)	16P(A)	18P(A)	20P(A)	22P(A)	24P(A)	26P(A)	28P(A)	30P(A)	32P(A)		34P(A)	36P(A)	38P(A)	40P(A)	42P(A)	44P(A)	46P(A)	48P(A)		
Heat Pump		5P(A)	8P(A)	10P(A)	12P(A)	14P(A)	16P(A)	18P(A)	20P(A)	22P(A)	24P(A)	26P(A)												Y1(E) YL(E)	
		28P(A)	30P(A)	32P(A)	34P(A)	36P(A)	38P(A)	40P(A)	42P(A)	44P(A)	46P(A)	48P(A)													
		50P(A)	52P(A)	54P(A)																					
		5P	8P	10P	12P	14P	16P	18P	20P	22P	24P	26P													TL(E)
		28P	30P	32P	34P	36P	38P	40P	42P	44P	46P	48P													
Cooling Only		50P	52P	54P																					
		5P(A)	8P(A)	10P(A)	12P(A)	14P(A)	16P(A)	18P(A)	20P(A)	22P(A)	24P(A)	26P(A)												Y1	
		28P(A)	30P(A)	32P(A)	34P(A)	36P(A)	38P(A)	40P(A)	42P(A)	44P(A)	46P(A)	48P(A)													
Heat Recovery		50P(A)	52P(A)	54P(A)																					
		8P	10P	12P	14P	16P	18P	20P	22P	24P	26P	28P													Y1
		30P	32P	34P	36P	38P	40P	42P	44P	46P	48P														

## 2-5. VRV VIII-Q P Series

### ■ Outdoor Units

Type		Model Name					Symbol
For Replacement Use	RQYQ	8P	10P	12P	14P	16P	Y1
		18P	20P	22P	24P	26P	
		28P	30P	32P	34P	36P	
		38P	40P	42P	44P	46P	
		48P					



## 2-7. VRV-WIII

Indoor Units	Type	Model Name													Symbol			
		FXFQ	FXZQ	FXCQ	FXKQ	FXDQ-PBVE	FXDQ-PBVE	FXDQ-NBVE	FXDQ-NBVE	FXMQ	FXMQ	FXHQ	FXAQ	FXLQ		FXNQ	FXUQ	BEVQ
Indoor Units	Ceiling Mounted Cassette Type (Round Flow)	-	20M	25M	32P	40P	50P	63P	80P	100P	125P	-	-	-	-	-	-	
	Ceiling Mounted Cassette Type (Compact Multi Flow)	20M	25M	32M	40M	50M	63M	80M	-	-	-	-	-	-	-	-	-	
	Ceiling Mounted Cassette Type (Double Flow)	20M	25M	32M	40M	50M	63M	80M	-	-	125M	-	-	-	-	-	-	
	Ceiling Mounted Cassette Corner Type	-	25MA	32MA	40MA	50MA	63MA	-	-	-	-	-	-	-	-	-	-	
	Slim Ceiling Mounted Duct Type	FXDQ-PBVE	20PB	25PB	32PB	-	-	-	-	-	-	-	-	-	-	-	-	-
		FXDQ-PBVE	20PB	25PB	32PB	-	-	-	-	-	-	-	-	-	-	-	-	-
		FXDQ-NBVE	-	-	-	40NB	50NB	63NB	-	-	-	-	-	-	-	-	-	-
		FXDQ-NBVE	-	-	-	40NB	50NB	63NB	-	-	-	-	-	-	-	-	-	-
	Ceiling Mounted Duct Type (Middle and High Static Pressure)	FXMQ	20P	25P	32P	40P	50P	63P	80P	100P	125P	140P	-	-	-	-	-	-
	Ceiling Mounted Duct Type	FXMQ	-	-	-	-	-	-	-	-	-	-	200MA	250MA	-	-	-	-
	Ceiling Suspended Duct Type	FXHQ	-	-	32MA	-	-	-	63MA	-	100MA	-	-	-	-	-	-	-
	Wall Mounted Type	FXAQ	20MA	25MA	32MA	40MA	50MA	63MA	-	-	-	-	-	-	-	-	-	-
	Floor Standing Type	FXLQ	20MA	25MA	32MA	40MA	50MA	63MA	-	-	-	-	-	-	-	-	-	-
	Concealed Floor Standing Type	FXNQ	20MA	25MA	32MA	40MA	50MA	63MA	-	-	-	-	-	-	-	-	-	-
	Ceiling Suspended Cassette Type	FXUQ	-	-	-	-	-	-	-	71MA	100MA	125MA	-	-	-	-	-	V1
	Connection Unit	BEVQ	-	-	-	-	-	-	-	71MA	100MA	125MA	-	-	-	-	-	-

## Outside Units

Outside Units	Type	Model Name						Symbol
		8P	10P	16P	18P	20P	24P	
Outside Units	Heat Pump Heat Recovery	RWEYQ	8P	10P	16P	18P	20P	Y1
			24P	26P	28P	30P		
			-	10P	-	-	20P	YL, TL
			-	-	-	30P	-	

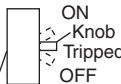

# 1. Symptom-based Troubleshooting

	Symptom	Supposed Cause	Countermeasure
1	The system does not start operation at all.	Blowout of fuse(s)	Turn OFF the power supply and then replace the fuse(s).
		Cutout of breaker(s)	<ul style="list-style-type: none"> <li>If the knob of any breaker is in its OFF position, turn ON the power supply.</li> <li>If the knob of any circuit breaker is in its tripped position, do not turn ON the power supply.</li> </ul>  <p>Circuit breaker</p>
		Power failure	After the power failure is reset, restart the system.
2	The system starts operation but makes an immediate stop.	Blocked air inlet or outlet of indoor or outdoor unit	Remove obstacle(s).
		Clogged air filter(s)	Clean the air filter(s).
3	The system does not cool or heat air well.	Blocked air inlet or outlet of indoor or outdoor unit	Remove obstacle(s).
		Clogged air filter(s)	Clean the air filter(s).
		Enclosed outdoor unit(s)	Remove the enclosure.
		Improper set temperature	Set the temperature to a proper degree.
		Airflow rate set to "LOW"	Set it to a proper airflow rate.
		Improper direction of air diffusion	Set it to a proper direction.
		Open window(s) or door(s)	Shut it tightly.
		[In cooling] Direct sunlight received	Hang curtains or shades on windows.
		[In cooling] Too many persons staying in a room	The model must be selected to match the air conditioning load
[In cooling] Too many heat sources			

	Symptom	Supposed Cause	Countermeasure	
4	The system does not operate.	The system stops and immediately restarts operation.	If the OPERATION lamp on the remote controller turns ON, the system will be normal. These symptoms indicate that the system is controlled so as not to put unreasonable loads on the system.	Normal operation. The system will automatically start operation after a lapse of 5 minutes.
		Pressing the TEMP ADJUST button immediately resets the system.		
		The remote controller displays "UNDER CENTRALIZED CONTROL", which blinks for a period of several seconds when the OPERATION button is depressed.	The system is controlled with centralized controller. Blinking display indicates that the system cannot be operated using the remote controller.	Operate the system using the COOL/HEAT centralized remote controller.
		The system stops immediately after turning ON the power supply.	The system is in preparation mode of micro computer operation.	Wait for a period of approximately 1 minute.
5	The system makes intermittent stops.	The remote controller displays error codes "U4" and "U5", and the system stops but restarts after a lapse of several minutes.	The system stops due to an interruption in communication between units caused by electrical noises coming from equipment other than air conditioners.	Remove causes of electrical noises. If these causes are removed, the system will automatically restart operation.
6	COOL-HEAT selection is disabled.	The remote controller displays "UNDER CENTRALIZED CONTROL".	This remote controller has no option to select cooling operation.	Use a remote controller with option to select cooling operation.
		The remote controller displays "UNDER CENTRALIZED CONTROL", and the COOL-HEAT selection remote controller is provided.	COOL-HEAT selection is made using the COOL-HEAT selection remote controller.	Use the COOL-HEAT selection remote controller to select cool or heat.

	Symptom		Supposed Cause	Countermeasure
7	The system conducts fan operation but not cooling or heating operation.	This symptom occurs immediately after turning ON the power supply.	The system is in preparation mode of operation.	Wait for a period of approximately 10 minutes.
8	The airflow rate is not reproduced according to the setting.	Even pressing the AIRFLOW RATE SET button makes no changes in the airflow rate.	In heating operation, when the room temperature reaches the set degree, the outdoor unit will stop while the indoor unit is brought to fan LL operation so that no one gets cold air. Furthermore, if fan operation mode is selected when other indoor unit is in heating operation, the system will be brought to fan LL operation. (The fan LL operation is also enabled while in oil return mode in cooling operation.)	Normal operation.
9	The airflow direction is not reproduced according to the setting.	The airflow direction is not corresponding to that displayed on the remote controller. The flap does not swing.	Automatic control	Normal operation.

	Symptom	Supposed Cause	Countermeasure	
10	A white mist comes out from the system.	<Indoor unit> In cooling operation, the ambient humidity is high. (This indoor unit is installed in a place with much oil or dust.)	Uneven temperature distribution due to heavy stain of the inside of the indoor unit	Clean the inside of the indoor unit.
		<Indoor unit> Immediately after cooling operation stopping, the ambient temperature and humidity are low.	Hot gas (refrigerant) flown in the indoor unit results to be vapor from the unit.	Normal operation.
		<Indoor and outdoor units> After the completion of defrosting operation, the system is switched to heating operation.	Defrosted moisture turns to be vapor and comes out from the units.	Normal operation.

	Symptom		Supposed Cause	Countermeasure
11	The system produces sounds.	<Indoor unit> Immediately after turning ON the power supply, indoor unit produces "ringing" sounds.	These are operating sounds of the electronic expansion valve of the indoor unit.	Normal operation. This sound becomes low after a lapse of approximately 1 minute.
		<Indoor and outdoor units> "Hissing" sounds are continuously produced while in cooling or defrosting operation.	These sounds are produced from gas (refrigerant) flowing respectively through the indoor and outdoor units.	Normal operation.
		<Indoor and outdoor units> "Hissing" sounds are produced immediately after the startup or stop of the system, or the startup or stop of defrosting operation.	These sounds are produced when the gas (refrigerant) stops or changes flowing.	Normal operation.
		<Indoor unit> Faint sounds are continuously produced while in cooling operation or after stopping the operation.	These sounds are produced from the drain discharge device in operation.	Normal operation.
		<Indoor unit> "Creaking" sounds are produced while in heating operation or after stopping the operation.	These sounds are produced from resin parts expanding and contracting with temperature changes.	Normal operation.
		<Indoor unit> Sounds like "trickling" or the like are produced from indoor units in the stopped state.	On VRV systems, these sounds are produced when other indoor units in operation. The reason is that the system runs in order to prevent oil or refrigerant from dwelling.	Normal operation.
		<Outdoor unit> Pitch of operating sounds changes.	The reason is that the compressor changes the operating	Normal operation.

## Symptom-based Troubleshooting

	Symptom		Supposed Cause	Countermeasure
12	Dust comes out from the system.	Dust comes out from the system when it restarts after the stop for an extended period of time.	Dust, which has deposited on the inside of indoor unit, is blown out from the system.	Normal operation.
13	Odors come out from the system.	In operation	Odors of room, cigarettes or else adsorbed to the inside of indoor unit are blown out.	The inside of the indoor unit should be cleaned.
14	Outdoor unit fan does not rotate.	In operation	The reason is that fan revolutions are controlled to put the operation to the optimum state.	Normal operation.
15	LCD display "88" appears on the remote controller.	Immediately after turning ON the power supply	The reason is that the system is checking to be sure the remote controller is normal.	Normal operation. This code is displayed for a period of approximately 1 minute at maximum.
16	The outdoor unit compressor or the outdoor unit fan does not stop.	After stopping operation	It stops in order to prevent oil or refrigerant from dwelling.	Normal operation. It stops after a lapse of approximately 5 to 10 minutes.
17	The outdoor unit gets hot.	While stopping operation	The reason is that the compressor is warmed up to provide smooth startup of the system.	Normal operation.
18	Hot air comes out from the system even though it stops.	Hot air is felt while the system stops.	On VRV systems, small quantity of refrigerant is fed to indoor units in the stopped state when other indoor units are in operation.	Normal operation.
19	The system does not cool air well.	The system is in dry operation.	The reason is that the dry operation serves not to reduce the room temperature where possible.	Change the system to cooling operation.

## 2. Troubleshooting by Remote Controller

### 2.1 The INSPECTION / TEST Button

The following modes can be selected by using the [Inspection/Test Operation] button on the remote control.

Indoor unit settings can be made

- Filter sign time
- Airflow direction
- Others

Service data can be obtained.

- Error code history
  - Temperature data of various sections
- Service settings can be made.
- Forced fan ON
  - Airflow direction/Airflow rate setting

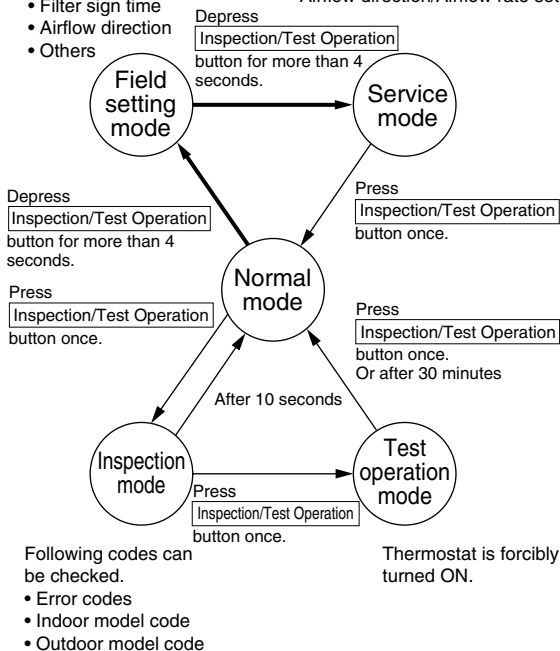

## 2.2 Self-diagnosis by Wired Remote Controller

### 2.2.1 Wired Remote Controller — BRC1D61

If operation stops due to error, the remote controller's operation LED blinks, and error code is displayed. (Even if stop operation is carried out, error contents are displayed when the inspection mode is entered.) The error code enables you to tell what kind of error caused operation to stop. Refer to P.24 for error code and error contents.

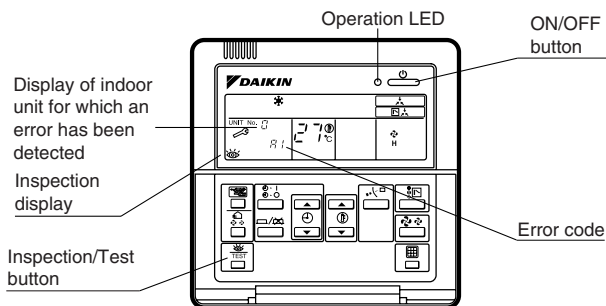

#### **i** Note:

1. Pressing the INSPECTION/TEST button will blink the check indication.
2. While in service mode, holding down the ON/OFF button for a period of 5 seconds or more will clear the error history indication shown above. In this case, on the codes display, the error code will blink twice and then change to "00" (= Normal), the Unit No. will change to "0", and the operation mode will automatically switch from service mode to normal mode (displaying the set temperature).



## 2.2.2 Wired Remote Controller — BRC1E61

The following will be displayed on the screen when an error (or a warning) occurs during operation.

Check the error code and take the corrective action specified for the particular model.

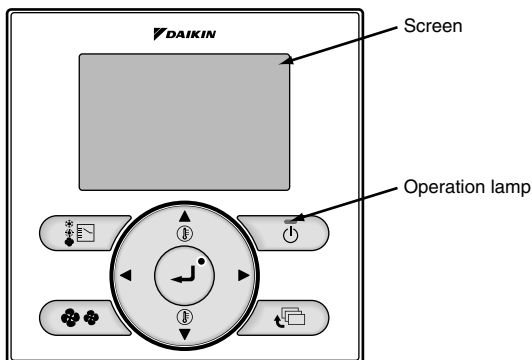

### (1) Checking an error or warning

	Operation Status	Display	
Abnormal shutdown	The system stops operating.	The operation lamp (green) starts to blink. The message "Error: Press Menu button" will appear and blink at the bottom of the screen.	
Warning	The system continues its operation.	The operation lamp (green) remains on. The message "Warning: Press Menu button" will appear and blink at the bottom of the screen.	

### (2) Taking corrective action

- Press the Menu/Enter button to check the error code.



- Take the corrective action specific to the model.

Error code:A1	— Error code
Contact address 0123-456-789	
Indoor Unit    FXMQ40PVE Outdoor Unit   RWEYQ10PY1	└ Applicable model names
← Return	

## 2.3 Self-diagnosis by Wireless Remote Controller

If unit stops due to an error, the operation indicating LED on the signal receiving part of indoor unit flashes. The error code can be determined by following the procedure described below. (The error code is displayed when an operation error has occurred. In normal condition, the error code of the last problem is displayed.)

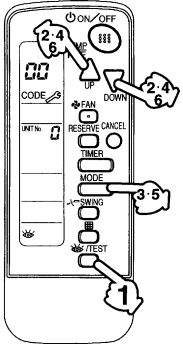
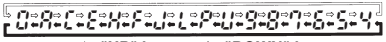
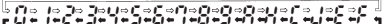
1	Press the INSPECTION/TEST button to select "inspection". The equipment enters the inspection mode. The "Unit" indication is displayed and the Unit No. display shows flashing "0" indication.	
2	Set the Unit No. Press the UP or DOWN button and change the Unit No. display until the buzzer (*1) is generated from the indoor unit. *1 Number of beeps <b>3 short beeps</b> : Conduct all of the following operations. <b>1 short beep</b> : Conduct steps 3 and 4. Continue the operation in step 4 until a buzzer remains ON. The continuous buzzer indicates that the error code is confirmed. <b>Continuous beep</b> : No abnormality.	
3	Press the MODE selector button. The left "0" (upper digit) indication of the error code flashes.	
4	Error code upper digit diagnosis Press the UP or DOWN button and change the error code upper digit until the error code matching buzzer (*2) is generated. ■ The upper digit of the code changes as shown below when the UP and DOWN buttons are pressed.  ⇨ "UP" button ⇐ "DOWN" button *2 Number of beeps <b>Continuous beep</b> : Both upper and lower digits matched. (Error code confirmed) <b>2 short beeps</b> : Upper digit matched. <b>1 short beep</b> : Lower digit matched.	
5	Press the MODE selector button. The right "0" (lower digit) indication of the error code flashes.	
6	Error code lower digit diagnosis Press the UP or DOWN button and change the error code lower digit until the continuous error code matching buzzer (*2) is generated. ■ The lower digit of the code changes as shown below when the UP and DOWN buttons are pressed. 	

## Normal status

Enters inspection mode from normal status when the INSPECTION/TEST button is pressed.

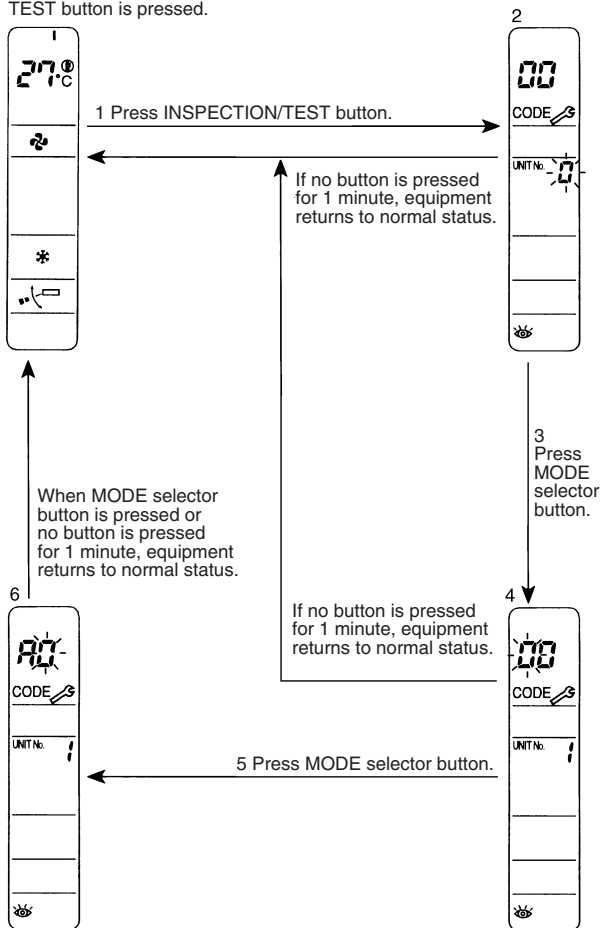

## 2.4 Error Codes and Description

### 2.4.1 Indoor Unit

#### ■ R-22

Error Code	Error Contents	FXC	FXF	FXK	FXD	FXYD	FXS	FXYB	FXM40-125L	FXM1200-230L	FXH	FXA	FXL	FXN	Reference Page
A0	External Protection Device Abnormality	●	●	●	●	●	●	●	●	●	●	●	●	●	46
A1	PCB Abnormality	●	●	●	●	●	●	●	●	●	●	●	●	●	48
A3	Drain Level Control System (S1L) Abnormality	●	●	●				●	●	●	●	●			49
A6	Fan Motor (M1F) Lock, Overload		●								●	●			52
A6	Indoor Unit Fan Motor Abnormality				●										55
A6	Overload / Overcurrent / Lock of Indoor Unit Fan Motor								●						57
A6	Overload / Overcurrent / Lock of Indoor Unit Fan Motor									●					61
A7	Swing Flap Motor (M1S) Abnormality	●	●	●							●	●			63
A9	Electronic Expansion Valve Coil Abnormality	●	●	●	●	●	●	●	●	●	●	●	●	●	68

Error Code	Error Contents	FXC	FXF	FXK	FXD	FXYD	FXS	FXYB	FXM40-125L	FXM200/250L	FXH	FXA	FXL	FXN	Reference Page
AF	Drain Level above Limit	●	●	●			●	●	●						71
AJ	Capacity Determination Device Abnormality	●	●	●	●	●	●	●	●	●	●	●	●	●	73
C4	Thermistor for Liquid Pipe Abnormality	●	●	●	●	●	●	●	●	●	●	●	●	●	78
C5	Thermistor for Gas Pipe Abnormality	●	●	●	●	●	●	●	●	●	●	●	●	●	80
C9	Thermistor for Suction Air Abnormality	●	●	●	●	●	●	●	●	●	●	●	●	●	84
CA	Thermistor for Discharge Air Abnormality	●	●	●	●	●	●	●	●	●	●	●	●	●	86
CJ	Room Temperature Thermistor in Remote Controller Abnormality	●	●	●	●	●	●	●	●	●	●	●	●	●	90

\* For the model names, refer to P.2~11.

## ■ R-410A

Error Code	Error Contents	FXCQ	FXZQ	FXFQ	FXKQ	FXDQ	FXSQ	FXMQ-P	FXMQ-MA	FXHQ	FXAQ	FXLQ	FXNQ	FXUQ	Reference Page
A0	External Protection Device Abnormality	●	●	●	●	●	●	●	●	●	●	●	●	●	46
A1	PCB Abnormality	●	●	●	●	●	●	●	●	●	●	●	●	●	48
A3	Drain Level Control System (S1L) Abnormality		●	●		●		●		●	●				49
A6	Fan Motor (M1F) Lock, Overload			●						●	●				52
A6	Indoor Unit Fan Motor Abnormality					●									55
A6	Overload / Overcurrent / Lock of Indoor Unit Fan Motor							●							57
A6	Overload / Overcurrent / Lock of Indoor Unit Fan Motor								●						61
A7	Swing Flap Motor (M1S) Abnormality	●			●					●				●	63
A8	Power Supply Voltage Abnormality							●							66
A9	Electronic Expansion Valve Coil Abnormality	●	●	●	●	●	●	●	●	●	●	●	●	●	68

\* For the model names, refer to P.2~11.

Error Code	Error Contents	FXCQ	FXZQ	FXFQ	FXKQ	FXDQ	FXSQ	FXMQ-P	FXMQ-MA	FXHQ	FXAQ	FXLQ	FXNQ	FXUQ	Reference Page
AF	Drain Level above Limit	●	●	●	●	●		●	●	●				●	71
AJ	Capacity Determination Device Abnormality	●	●	●	●	●	●	●	●	●	●	●	●	●	73
C1	Transmission Abnormality (between Indoor unit PCB and Fan PCB)							●							75
C4	Thermistor for Liquid Pipe Abnormality	●	●	●	●	●	●	●	●	●	●	●	●	●	78
C5	Thermistor for Gas Pipe Abnormality	●	●	●	●	●	●	●	●	●	●	●	●	●	80
C6	Combination Abnormality (between Indoor unit PCB and Fan PCB)							●							82
C9	Thermistor for Suction Air Abnormality	●	●	●	●	●	●	●	●	●	●	●	●	●	84
CA	Thermistor for Discharge Air Abnormality	●	●	●	●	●	●	●	●	●	●	●	●	●	86
CC	Humidity Sensor System Abnormality			●											88
CJ	Room Temperature Thermistor in Remote Controller Abnormality	●	●	●	●	●	●	●	●	●	●	●	●	●	90

\* For the model names, refer to P.2~11.



## 2.4.2 Outdoor Unit

Refrigerant	Series	R-22				R-410A								Reference Page			
		VRV7	VRV7-S	VRV7	VRV8	VRV-W7II	VRV-WIII	VRV7-S	VRV7-S	VRV8-S	VRV8-S	VRV8-Q					
		M(A)	M	M(A)	P(A)	M	P	M	P	M	P						
or Contents																	
1	PCB Abnormality	●	●	●	●	●	●	●	●	●	●	●	●	●	●	●	92
2	Earth Leakage by Leak Detection PCB Assy				●	●	●										94
3	Actuation of High Pressure Sensor	●	●	●													97
4	Abnormal Discharge Pressure				●	●	●	●	●	●	●	●	●	●	●	●	99
5	Actuation of Low Pressure Sensor	●	●	●													102
6	Abnormal Suction Pressure				●	●	●	●	●	●	●	●	●	●	●	●	104
7	Inverter Compressor Motor Lock	●	●	●													107
8	Inverter Compressor Motor Lock				●	●	●	●	●	●	●	●	●	●	●	●	109
9	Inverter Compressor Motor Lock							●	●	●	●	●	●	●	●	●	112
10	STD Compressor Motor Overcurrent/Lock	●						●	●	●	●	●	●	●	●	●	115
11	Outdoor Unit Fan Motor Abnormality							●	●	●	●	●	●	●	●	●	117
12	Outdoor Unit Fan Motor Abnormality												●	●	●	●	121
13	Outdoor Unit Fan Motor Abnormality		●														125
14	Outdoor Unit Fan Motor Abnormality	●		●													127
15	Electronic Expansion Valve Coil Abnormality																130
16	Electronic Expansion Valve Coil Abnormality	●	●	●				●	●	●	●	●	●	●	●	●	133
17	Abnormal Discharge Pipe Temperature																136
18	Abnormal Discharge Pipe Temperature																139



Refrigerant	R-22						R-410A						Reference Page
	VRVII		VRVII-S		VRVII	VRVIII	VRV-WIII	VRV-WIII	VRVII-S	VRVIII-S	VRVIII-Q		
	M(A)	M		P(A)	M	P	M	P	M	P	P		
8	Thermistor System Abnormality												178
9	Subcooling/Heat Exchanger Gas Pipe Thermistor Abnormality												180
A	High Pressure Sensor Abnormality												182
	Discharge Pipe Pressure Sensor Abnormality												185
C	Low Pressure Sensor Abnormality												188
	Suction Pipe Pressure Sensor Abnormality												191
1	Inverter PCB Abnormality												194
	Inverter PCB Abnormality												197
	Inverter PCB Abnormality												200
4	Inverter Radiation Fin Temperature Rise Abnormality												202
	Inverter Radiation Fin Temperature Rise Abnormality												205
5	Momentary Overcurrent of Inverter Compressor												207
	Momentary Overcurrent of Inverter Compressor												210
8	Momentary Overcurrent of Inverter Compressor												213
	Momentary Overcurrent of Inverter Compressor												216

Error Contents	R-22		R-410A							Reference Page		
	VRV7 M(A)	VRV7-S M	VRV7 M(A)	VRV8 P(A)	VRV-W7 M	VRV-W8 P	VRV7-S M	VRV8-S P	VRV8-Q P			
	Refrigerant Series											
9				●		●						219
C	●	●			●	●				●		223
				●			●			●		226
		●			●	●				●		229
1	●					●						231
	●					●				●		234
4						●						237
							●			●		239
J	●	●			●	●						241
				●			●					243
							●					245

Error Contents	R-22		R-410A						Reference Page	
	VRVII	VRVII-S	VRVII	VRV-WIII	VRV-WIII	VRVII-S	VRVIII-S	VRVIII-Q		
	M(A)	M	M(A)	P(A)	M	P	M	P		
J Field Setting Abnormality after Replacing Main PCB or Combination of PCB Abnormality	●		●							247
		●			●					
K Refrigerant Shortage Alert				●					●	250
					●					
L Refrigerant Shortage Alert	●		●							256
	●		●		●				●	
M Reverse Phase, Open Phase										261
				●						
N Power Supply Insufficient or Instantaneous Error										269
									●	
O Power Supply Insufficient or Instantaneous Error	●									277

Refrigerant	R-22		R-410A								Reference Page		
	VRV7	VRV7-S	VRV7	VRV7	VRV7	VRV7-S	VRV7-S	VRV7-S	VRV7-S	VRV7-S			
	M(A)	M	M(A)	M(A)	P(A)	M	P	M	P	P			
Series													
Contents													
2 Power Supply Insufficient or Instantaneous Error		●				●							280
3 Check Operation is not Executed	●	●	●			●							283
4 Transmission Error between Indoor Units and Outdoor Units					●								285
Transmission Error between Indoor Units and Outdoor Units												●	289
Transmission Error between Indoor Units and Outdoor Units	●	●	●			●							294
Transmission Error between Remote Controller and Indoor Unit	●	●	●			●							298
Transmission Error (Across Outdoor Units)												●	300
Transmission Error (Across Outdoor Units)	●		●			●							311
Transmission Error between Main and Sub Remote Controllers	●	●	●			●							314
Transmission Error between Indoor and Outdoor Units in the Same System												●	316
Transmission Error between Indoor and Outdoor Units in the Same System	●	●	●			●							318



## 2.5 Error Codes - Sub Codes

If an error code like the one shown below is displayed when the navigation remote controller (BRC1E61 or 71) is in use, make a detailed diagnosis or a diagnosis of the relevant unit referring to the attached list of detailed error codes.

### 2.5.1 Indoor Unit

Error code	Troubleshooting	
	Description of error	Description of diagnosis
A6 - 01	Fan motor locked	A locked fan motor current has been detected. Turn the fan by hand to check for the connection of connectors.
A6 - 10	Fan overcurrent error	A fan motor overcurrent has been detected. Check for the connection of the connector between the fan motor and the PCB for the fan. If the connection is normal, replace the fan motor. If this still cannot solve the error, replace the PCB for the fan.
A6 - 11	Fan position detection error	An error in the detection of position of the fan motor. Check for the connection of the connector between the fan motor and the PCB for the fan. If the connection is normal, replace the fan motor. If this still cannot solve the error, replace the PCB for the fan.
A8 - 01	Power supply voltage error	Check for the input voltage of the fan motor.
A9 - 01	Electronic expansion valve error	There is an error in the expansion valve coil or a connector disconnected.
A9 - 02	Refrigerant leakage detection error	Refrigerant leaks even if the electronic expansion valve is closed. Replace the electronic expansion valve.



Error code	Troubleshooting	
	Description of error	Description of diagnosis
AH - 03	Transmission error (between the self-cleaning decoration panel and the indoor unit) [when the self-cleaning decoration panel is mounted]	Check for the connection of the harness connector between the panel PCB and the indoor unit PCB.
AH - 04	Dust detection sensor error [when the self-cleaning decoration panel is mounted]	Check for the connections of the connector X12A on the panel PCB and the connectors X18A and X19A on the sensor PCB.
AH - 05	Dust collection sign error [when the self-cleaning decoration panel is mounted]	Check for clogging with dust at the dust collection port as well as in the brush unit, S-shaped pipe, and dust box. Furthermore, check for any stains of the light receiving and emitting parts of the infrared unit.
AH - 06	Air filter rotation error [when the self-cleaning decoration panel is mounted]	Check for anything getting in the way of rotating the filter (e.g. the filter comes off or the drive gear is clogged with foreign matters).
AH - 07	Damper rotation error [when the self-cleaning decoration panel is mounted]	The damper does not rotate normally. Check for any foreign matters around the damper and for the operation of the gear and limit switch.
AH - 08	Filter self-cleaning operation error [when the self-cleaning decoration panel is mounted]	The unit has not yet completed the filter self-cleaning operation even after the lapse of specified period of time. Check for any external noise, etc.
AH - 09	Filter self-cleaning operation start disabled error [when the self-cleaning decoration panel is mounted]	The unit has been put into a state in which the filter self-cleaning operation is disabled. Check the unit for the operating conditions.
AJ - 01	Capacity setting error	There is an error in the capacity setting of the indoor unit PCB.
AJ - 02	Electronic expansion valve setting error	There is a fault in the setting of the gear type electronic expansion valve/direct acting type electronic expansion valve.
C1 - 01	Transmission error (between indoor unit PCB and the PCB for the fan)	Check for the conditions of transmission between the indoor unit PCB and the PCB for the fan.

Error code	Troubleshooting	
	Description of error	Description of diagnosis
C6 - 01	Faulty combination of indoor unit PCB and the PCB for the fan	A combination of indoor unit PCB and the PCB for the fan is faulty. Check whether the capacity setting adaptor is correct and the type of the PCB for the fan is correct.
U4 - 01	Indoor-Outdoor transmission error	Refer to the "U4" flow chart.
UA - 13	Refrigerant type error	The type of refrigerant used for the indoor unit is different from that used for the outdoor unit.
UA - 15	Not applicable for self-cleaning decoration panel [when the self-cleaning decoration panel is mounted]	An outdoor unit is not applicable for the self-cleaning decoration panel is connected.

## 2.5.2 Outdoor Unit

Error code	Troubleshooting	
	Description of error	Description of diagnosis
E3 - 01 E3 - 02	High pressure switch activated (Master)	Refer to the "E3" flow chart of each manual and make a diagnosis of the relevant unit based on the Error code shown to the left.
E3 - 03 E3 - 04	High pressure switch activated (Slave 1)	
E3 - 05 E3 - 06	High pressure switch activated (Slave 2)	
E3 - 07	High pressure switch activated (Batch)	
E4 - 01 E4 - 02 E4 - 03	Low pressure error (Master) Low pressure error (Slave 1) Low pressure error (Slave 2)	
E5 - 01 E5 - 02 E5 - 03	INV. compressor lock (Master) INV. compressor lock (Slave 1) INV. compressor lock (Slave 2)	Refer to the "E5" flow chart of each manual and make a diagnosis of the relevant unit based on the Error code shown to the left.
E6 - 01 E6 - 02 E6 - 03 E6 - 04 E6 - 05 E6 - 06	STD compressor 1 OC activated (Master) STD compressor 2 OC activated (Master) STD compressor 1 OC activated (Slave 1) STD compressor 2 OC activated (Slave 1) STD compressor 1 OC activated (Slave 2) STD compressor 2 OC activated (Slave 2)	Refer to the "E6" flow chart of each manual and make a diagnosis of the relevant compressor of the relevant unit based on the Error code shown to the left.

## Troubleshooting by Remote Controller

Error code	Troubleshooting		
	Description of error	Description of diagnosis	
E7 - 01	Fan motor 1 lock (Master)	Refer to the following to make a diagnosis of the fan motor of the relevant unit.	
E7 - 02	Fan motor 2 lock (Master)		
E7 - 05	Fan motor 1 instantaneous overcurrent (Master)		
E7 - 06	Fan motor 2 instantaneous overcurrent (Master)		
E7 - 09	Fan motor 1 IPM error (Master)		
E7 - 10	Fan motor 2 IPM error (Master)		
E7 - 13	Fan motor 1 lock (Slave 1)		○ For fan motor lock, refer to E7-01, -02, -13, -14, -25, and -26.
E7 - 14	Fan motor 2 lock (Slave 1)		
E7 - 17	Fan motor 1 instantaneous overcurrent (Slave 1)		
E7 - 18	Fan motor 2 instantaneous overcurrent (Slave 1)		
E7 - 21	Fan motor 1 IPM error (Slave 1)	○ For instantaneous overcurrent, refer to E7-05, -06, -17, -18, -29, and -30.	
E7 - 22	Fan motor 2 IPM error (Slave 1)		
E7 - 25	Fan motor 1 lock (Slave 2)	○ For IPM error, refer to E7-09, -10, -21, -22, -33, and -34.	
E7 - 26	Fan motor 2 lock (Slave 2)		
E7 - 29	Fan motor 1 instantaneous overcurrent (Slave 2)		
E7 - 30	Fan motor 2 instantaneous overcurrent (Slave 2)		
E7 - 33	Fan motor 1 IPM error (Slave 2)		
E7 - 34	Fan motor 2 IPM error (Slave 2)		
E9 - 01	Electronic expansion valve 1 coil error (Master)	Refer to the "E9" flow chart of each manual and make a diagnosis of the relevant electronic expansion valve of the relevant unit based on the Error code shown to the left.	
E9 - 04	Electronic expansion valve 2 coil error (Master)		
E9 - 05	Electronic expansion valve 1 coil error (Slave 1)		
E9 - 07	Electronic expansion valve 2 coil error (Slave 1)		
E9 - 08	Electronic expansion valve 1 coil error (Slave 2)		
E9 - 10	Electronic expansion valve 2 coil error (Slave 2)		
F3 - 01	Discharge pipe temperature error (Master)	Refer to the "F3" flow chart of each manual and make a diagnosis of the relevant unit based on the Error code shown to the left.	
F3 - 03	Discharge pipe temperature error (Slave 1)		
F3 - 05	Discharge pipe temperature error (Slave 2)		

Error code	Troubleshooting	
	Description of error	Description of diagnosis
F6 - 02	Excess refrigerant charge error	Excess refrigerant charge was detected during test run.
F6 - 03	Excess refrigerant charge warning	Excess refrigerant charge was detected during operation other than test run.
H7 - 01	Fan motor 1 signal error (Master)	Refer to the "H7" flow chart of each manual and make a diagnosis of the relevant unit based on the Error code shown to the left.
H7 - 02	Fan motor 2 signal error (Master)	
H7 - 05	Fan motor 1 signal error (Slave 1)	
H7 - 06	Fan motor 2 signal error (Slave 1)	
H7 - 09	Fan motor 1 signal error (Slave 2)	
H7 - 10	Fan motor 2 signal error (Slave 2)	
H9 - 01	Faulty outdoor air thermistor (Master)	Refer to the "H9" flow chart of each manual and make a diagnosis of the relevant unit based on the Error code shown to the left.
H9 - 02	Faulty outdoor air thermistor (Slave 1)	
H9 - 03	Faulty outdoor air thermistor (Slave 2)	
J2 - 01	Faulty current sensor (Master: STD compressor 1)	Refer to the "J2" flow chart of each manual and make a diagnosis of the relevant compressor of the relevant unit based on the Error code shown to the left.
J2 - 02	Faulty current sensor (Master: STD compressor 2)	
J2 - 03	Faulty current sensor (Slave 1: STD compressor 1)	
J2 - 04	Faulty current sensor (Slave 1: STD compressor 2)	
J2 - 05	Faulty current sensor (Slave 2: STD compressor 1)	
J2 - 06	Faulty current sensor (Slave 2: STD compressor 2)	
J2 - 07	Current sensor error (System)	

Error code	Troubleshooting	
	Description of error	Description of diagnosis
J3 - 01	Faulty discharge pipe thermistor 1 (Master: INV. compressor)	Refer to the "J3" flow chart of each manual and make a diagnosis of the relevant compressor of the relevant unit based on the Error code shown to the left.
J3 - 02	Faulty discharge pipe thermistor 2 (Master: STD compressor 1)	
J3 - 03	Faulty discharge pipe thermistor 3 (Master: STD compressor 2)	
J3 - 04	Faulty discharge pipe thermistor 1 (Slave 1: INV. compressor)	
J3 - 05	Faulty discharge pipe thermistor 2 (Slave 1: STD compressor 1)	
J3 - 06	Faulty discharge pipe thermistor 3 (Slave 1: STD compressor 2)	
J3 - 07	Faulty discharge pipe thermistor 1 (Slave 2: INV. compressor)	
J3 - 08	Faulty discharge pipe thermistor 2 (Slave 2: STD compressor 1)	
J3 - 09	Faulty discharge pipe thermistor 3 (Slave 2: STD compressor 2)	
J5 - 01	Faulty suction pipe thermistor (Master)	Refer to the "J5" flow chart of each manual and make a diagnosis of the relevant thermistor of the relevant unit based on the Error code shown to the left.
J5 - 02	Faulty accumulator inlet thermistor (Master)	
J5 - 03	Faulty suction pipe thermistor (Slave 1)	
J5 - 04	Faulty accumulator inlet thermistor (Slave 1)	
J5 - 05	Faulty suction pipe thermistor (Slave 2)	
J5 - 06	Faulty accumulator inlet thermistor (Slave 2)	

Error code	Troubleshooting	
	Description of error	Description of diagnosis
J6 - 01	Faulty heat exchanger thermistor (Master)	Refer to the "J6" flow chart of each manual and make a diagnosis of the relevant thermistor based on the Error code shown to the left.
J6 - 02	Faulty heat exchanger thermistor (Slave 1)	
J6 - 03	Faulty heat exchanger thermistor (Slave 2)	
J7 - 01	Faulty liquid pipe thermistor (Master)	Refer to the "J7" flow chart of each manual and make a diagnosis of the relevant thermistor based on the Error code shown to the left.
J7 - 02	Faulty liquid pipe thermistor (Slave 1)	
J7 - 03	Faulty liquid pipe thermistor (Slave 2)	
J9 - 01	Faulty subcooling heat exchanger outlet thermistor (Master)	Refer to the "J9" flow chart of each manual and make a diagnosis of the relevant thermistor based on the Error code shown to the left.
J9 - 02	Faulty subcooling heat exchanger outlet thermistor (Slave 1)	
J9 - 03	Faulty subcooling heat exchanger outlet thermistor (Slave 2)	
JA - 01	Faulty high pressure sensor (Master)	Refer to the "JA" flow chart of each manual and make a diagnosis of the relevant sensor based on the Error code shown to the left.
JA - 02	Faulty high pressure sensor (Slave 1)	
JA - 03	Faulty high pressure sensor (Slave 2)	
JC - 01	Faulty low pressure sensor (Master)	Refer to the "JC" flow chart of each manual and make a diagnosis of the relevant sensor based on the Error code shown to the left.
JC - 02	Faulty low pressure sensor (Slave 1)	
JC - 03	Faulty low pressure sensor (Slave 2)	
L1 - 01	Instantaneous overcurrent (Master: Inverter PCB)	The inverter PCB may be faulty. Refer to the "L1" flow chart of each manual and make a diagnosis of the relevant unit based on the Error code shown to the left.
L1 - 02	Current sensor error (Master: Inverter PCB)	
L1 - 03	Current offset error (Master: Inverter PCB)	

Error code	Troubleshooting	
	Description of error	Description of diagnosis
L1 - 04	IGBT error (Master: Inverter PCB)	The inverter PCB may be faulty or a PCB other than the specified one is mounted. Refer to the "L1" flow chart of each manual and make a diagnosis of the relevant unit based on the Error code shown to the left.
L1 - 07	Instantaneous overcurrent (Slave 1: Inverter PCB)	The inverter PCB may be faulty. Refer to the "L1" flow chart of each manual and make a diagnosis of the relevant unit based on the Error code shown to the left.
L1 - 08	Current sensor error (Slave 1: Inverter PCB)	
L1 - 09	Current offset error (Slave 1: Inverter PCB)	
L1 - 10	IGBT error (Slave 1: Inverter PCB)	The inverter PCB may be faulty or a PCB other than the specified one is mounted. Refer to the "L1" flow chart of each manual and make a diagnosis of the relevant unit based on the Error code shown to the left.
L1 - 12	Instantaneous overcurrent (Slave 2: Inverter PCB)	The inverter PCB may be faulty. Refer to the "L1" flow chart of each manual and make a diagnosis of the relevant unit based on the Error code shown to the left.
L1 - 13	Current sensor error (Slave 2: Inverter PCB)	
L1 - 14	Current offset error (Slave 2: Inverter PCB)	
L1 - 15	IGBT error (Slave 2: Inverter PCB)	The inverter PCB may be faulty or a PCB other than the specified one is mounted. Refer to the "L1" flow chart of each manual and make a diagnosis of the relevant unit based on the Error code shown to the left.
L4 - 01	Radiation fin temperature rise (Master: Inverter PCB)	Refer to the "L4" flow chart of each manual and make a diagnosis of the relevant unit based on the Error code shown to the left.
L4 - 02	Radiation fin temperature rise (Slave 1: Inverter PCB)	
L4 - 03	Radiation fin temperature rise (Slave 2: Inverter PCB)	
L5 - 03	Current offset error (Master)	Refer to the "L5" flow chart of each manual and make a diagnosis of the relevant unit based on the Error code shown to the left.
L5 - 05	Current offset error (Slave 1)	
L5 - 07	Current offset error (Slave 2)	



Error code	Troubleshooting	
	Description of error	Description of diagnosis
L8 - 03	INV. compressor instantaneous overcurrent error (Master)	Refer to the "L8" flow chart of each manual and make a diagnosis of the relevant compressor of the relevant unit based on the Error code shown to the left.
L8 - 06	INV. compressor instantaneous overcurrent error (Slave 1)	
L8 - 07	INV. compressor instantaneous overcurrent error (Slave 2)	
L9 - 01	INV. compressor startup failure (Master)	Refer to the "L9" flow chart of each manual and make a diagnosis of the relevant compressor of the relevant unit based on the Error code shown to the left.
L9 - 05	INV. compressor startup failure (Slave 1)	
L9 - 06	INV. compressor startup failure (Slave 2)	
LC - 01	Transmission error [between INV. PCB and main PCB] (Master)	Refer to the "LC1" flow chart of each manual and make a diagnosis of the relevant unit based on the Error code shown to the left.
LC - 06	Transmission error [between INV. PCB and main PCB] (Slave 1)	
LC - 08	Transmission error [between INV. PCB and main PCB] (Slave 2)	
P1 - 01	Unbalanced power supply voltage (Master)	Refer to the "P1" flow chart of each manual and make a diagnosis of the relevant unit based on the Error code shown to the left.
P1 - 02	Unbalanced power supply voltage (Slave 1)	
P1 - 03	Unbalanced power supply voltage (Slave 2)	
PJ - 04	Faulty combination of INV. PCB (Master)	Refer to the "PJ" flow chart of each manual and make a diagnosis of the relevant unit based on the Error code shown to the left.
PJ - 05	Faulty combination of INV. PCB (Slave 1)	
PJ - 06	Faulty combination of INV. PCB (Slave 2)	
U0 - 03	Gas shortage alarm	Refer to the "U0" flow chart.

Error code	Troubleshooting	
	Description of error	Description of diagnosis
U1 - 01	Reverse phase/open phase for power supply (Master)	Refer to the "U1" flow chart of each manual and make a diagnosis of the relevant unit based on the Error code shown to the left.
U1 - 04	Reverse phase for power supply [with power supply turned ON] (Master)	
U1 - 05	Reverse phase/open phase for power supply (Slave 1)	
U1 - 06	Reverse phase for power supply [with power supply turned ON] (Slave 1)	
U1 - 07	Reverse phase/open phase for power supply (Slave 2)	
U1 - 08	Reverse phase for power supply [with power supply turned ON] (Slave 2)	

## 3. Troubleshooting by Indication on the Remote Controller

### 3.1 External Protection Device Abnormality

#### Remote Controller Display



#### Applicable Models

All indoor models

#### Method of Error Detection

Detect open or short circuit between external input terminals in indoor unit.

#### Error Decision Conditions

When an open circuit occurs between external input terminals with the remote controller set to "external ON/OFF terminal".

#### Supposed Causes

- Actuation of external protection device
- Improper field setting
- Defective indoor unit PCB

## Troubleshooting



### Caution

Be sure to turn off the power switch before connecting or disconnecting connectors, or parts may be damaged.

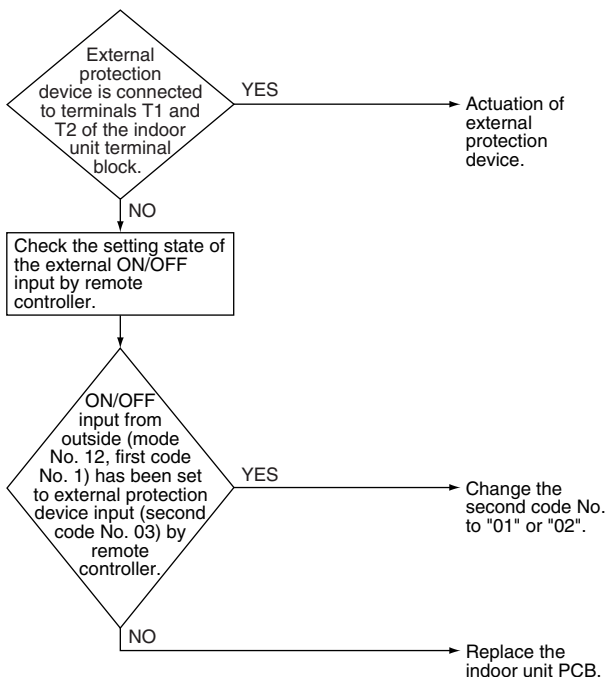

## 3.2 R1 PCB Abnormality

### Remote Controller Display

R1

### Applicable Models

All indoor models

### Method of Error Detection

Check data from E<sup>2</sup>PROM.

### Error Decision Conditions

When data could not be correctly received from the E<sup>2</sup>PROM

E<sup>2</sup>PROM : Type of nonvolatile memory. Maintains memory contents even when the power supply is turned OFF.

### Supposed Causes

- Defective indoor unit PCB
- External factor (Noise etc.)

### Troubleshooting



**Caution**

Be sure to turn off the power switch before connecting or disconnecting connectors, or parts may be damaged.

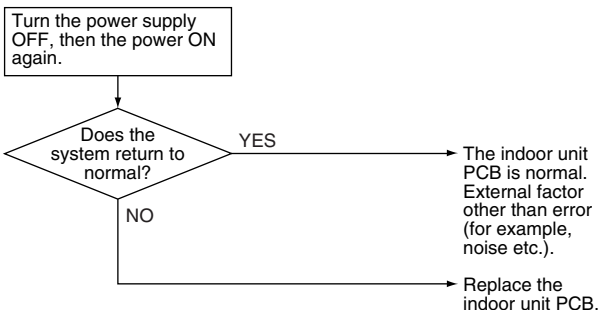

## 3.3 Drain Level Control System (S1L) Abnormality

### Remote Controller Display



### Applicable Models

R-22: FXC, FXF, FXA, FXK, FXH (Option), FXM (Option), FXYB

R-410A: FXFQ, FXZQ, FXDQ, FXMQ-P, FXHQ (Option), FXAQ (Option)

### Method of Error Detection

By float switch OFF detection

### Error Decision Conditions

When rise of water level is not a condition and the float switch goes OFF

### Supposed Causes

- Proper power supply is not provided
- Defective float switch or short circuit connector
- Defective drain pump
- Drain clogging, upward slope, etc.
- Defective indoor unit PCB
- Loose connection of connector

## Troubleshooting



### Caution

Be sure to turn off the power switch before connecting or disconnecting connectors, or parts may be damaged.

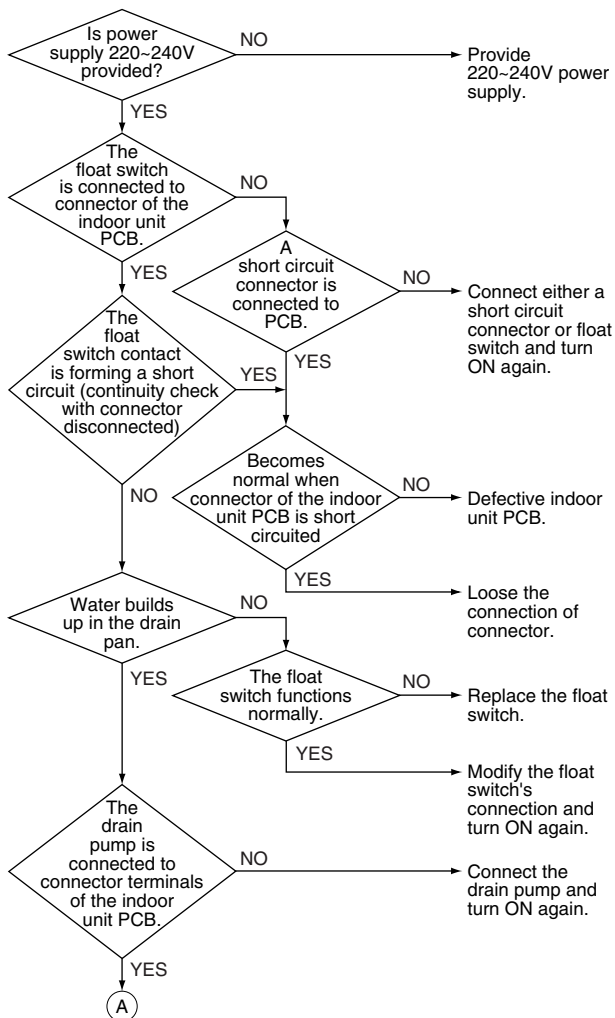

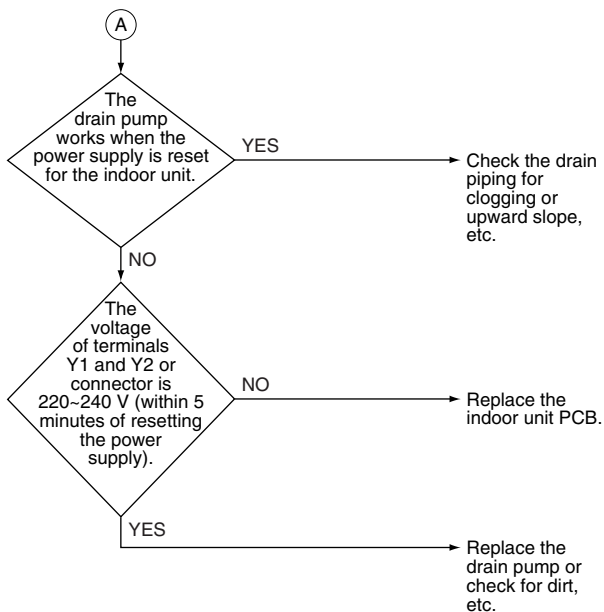



## 3.4 **88** Fan Motor (M1F) Lock, Overload

### Remote Controller Display

**88**

### Applicable Models

R-22: FXA, FXF, FXH

R-410A: FXAQ, FXFQ, FXHQ

### Method of Error Detection

Abnormal fan revolutions are detected by a signal output from the fan motor.

### Error Decision Conditions

When the fan revolutions do not increase

### Supposed Causes

- Broken wires, short circuits, and loose connections in the fan motor harness
- Defective fan motor  
(Broken wires or defective insulation)
- Abnormal signal output from the fan motor (defective circuit)
- Defective PCB
- Instantaneous disturbance in the power supply voltage
- Fan motor lock  
(Due to motor or external causes)
- The fan does not rotate due to foreign matters blocking the fan.
- Disconnection of the connector between the high-power PCB and the low-power PCB.

## Troubleshooting



### Caution

Be sure to turn off the power switch before connecting or disconnecting connectors, or parts may be damaged.

Turn OFF the power supply, and then wait for a period of 10 minutes.

Are there any foreign matters around the fan?

YES

Remove the foreign matters.

NO

Is the connector for the fan motor properly connected to the indoor unit PCB? (\*1)

NO

Properly connect the connector.

YES

By disconnecting the connector for the fan motor from the indoor unit PCB, the fan can be lightly rotated by hand.

NO

Replace the fan motor.

YES

Disconnect the connector from the fan motor, and then make measurement of resistance between pins. (\*2)

Is the resistance between the pins more than the judgement criteria?

NO

Replace the fan motor.

YES

Replace the

**i Note:**

- \*1. If any junction connector is provided between the connector on the indoor unit PCB and the fan motor, also check whether or not the junction connector is properly connected.
- \*2. All resistance measuring points and judgement criteria.

(Example)

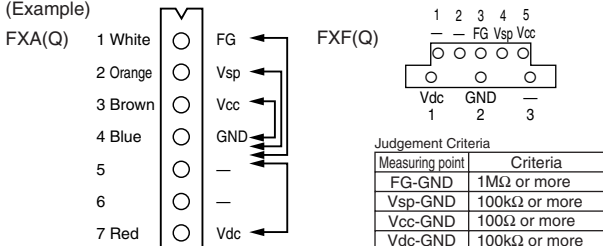

Judgement Criteria

Measuring point	Criteria
FG-GND	1M $\Omega$ or more
Vsp-GND	100k $\Omega$ or more
Vcc-GND	100 $\Omega$ or more
Vdc-GND	100k $\Omega$ or more

## 3.5 Indoor Unit Fan Motor Abnormality

### Remote Controller Display



### Applicable Models

FXD(Q)

### Method of Error Detection

This error is detected if there is no revolutions detection signal output from the fan motor.

### Error Decision Conditions

When no revolutions can be detected even at the maximum output voltage to the fan

### Supposed Causes

- Defective indoor fan motor
- Broken wires
- Defective contact

## Troubleshooting



### Caution

Be sure to turn off the power switch before connecting or disconnecting connectors, or parts may be damaged.

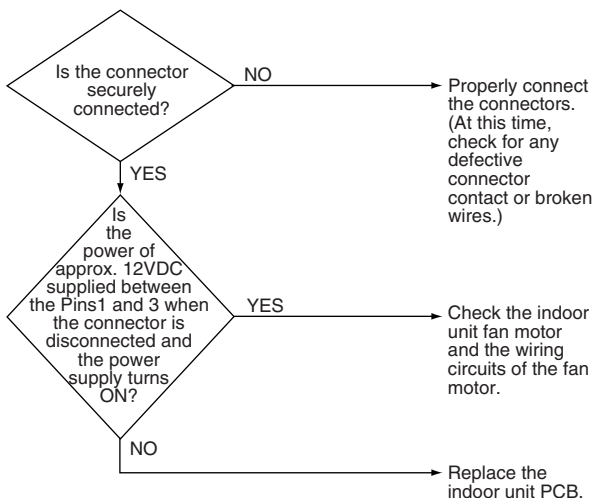

## 3.6 **⚠️ Overload/Overcurrent/Lock of Indoor Unit Fan Motor**

### Remote Controller Display



### Applicable Models

R-22: FXM40~125L

R-410A: FXMQ50~140P

### Method of Error Detection

Detection from the current flow on the fan PCB.

Detection from the RPM of the fan motor in operation.

Detection from the position signal of the fan motor.

Detection from the current flow on the fan PCB when the fan motor starting operation.

### Error Decision Conditions

- An overcurrent flows.
- The RPM is less than a certain level for 6 seconds.
- A position error in the fan rotor continues for 5 seconds or more.
- An overcurrent flow.

### Supposed Causes

- The clogging of a foreign matter
- The disconnection of the fan motor connectors
- The disconnection of the connectors between the indoor unit PCB and fan PCB
- Defective fan PCB
- Defective fan motor

## Troubleshooting



### Caution

Be sure to turn off the power switch before connecting or disconnecting connectors, or parts may be damaged.

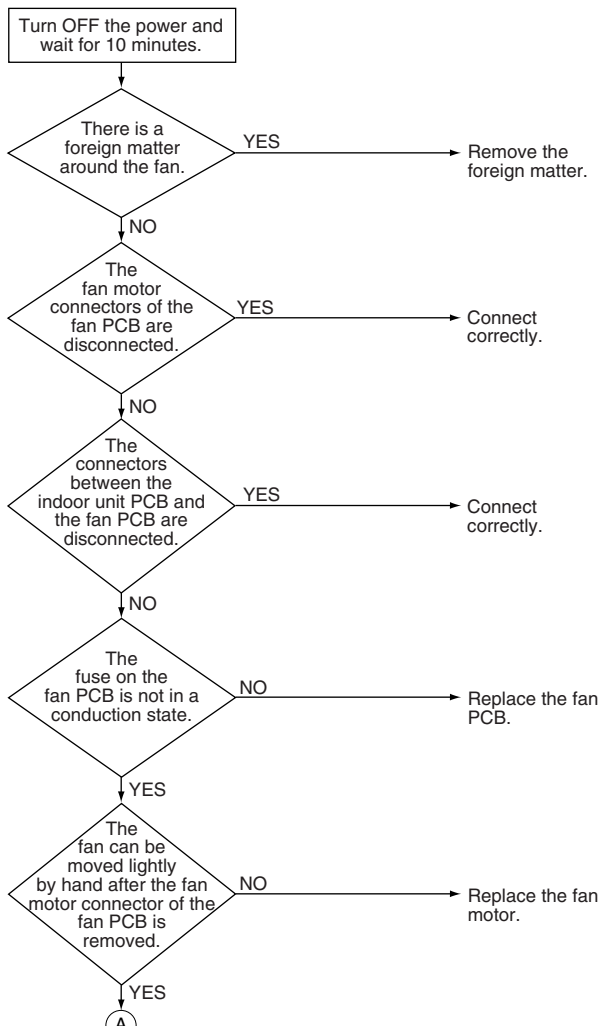

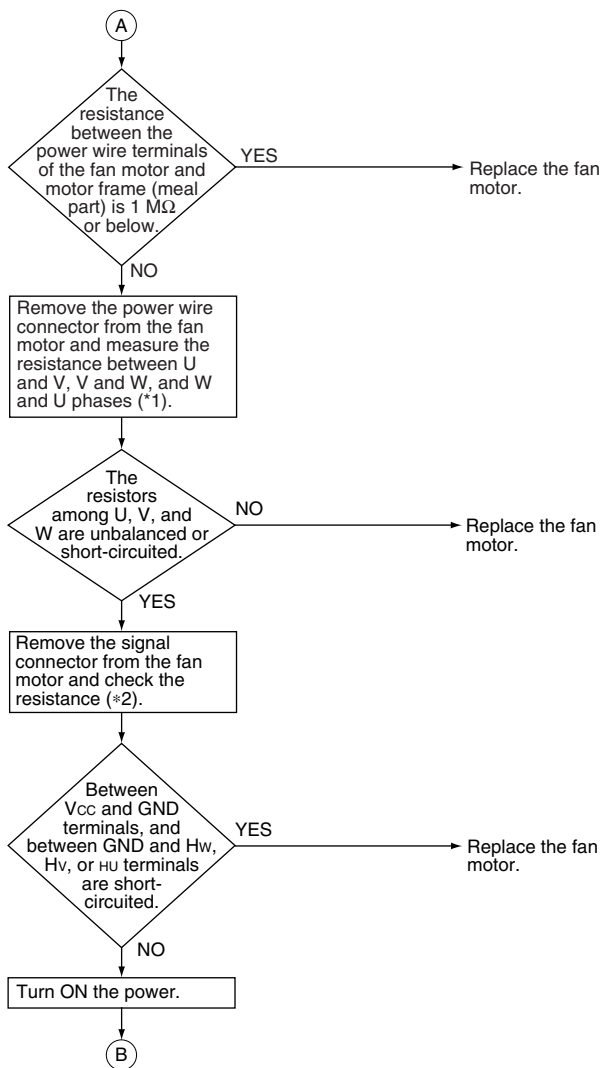



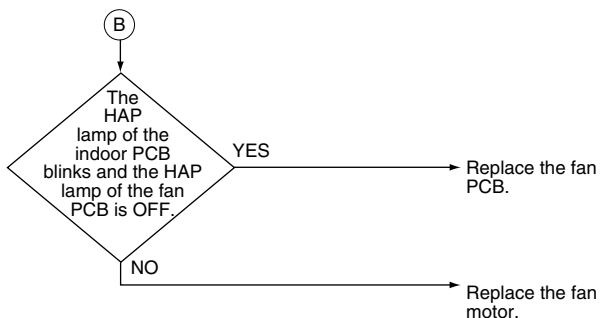

**i Note:**

- \*1. Measurement of power wire connector.  
Remove the connector from the fan PCB and measure the resistance between the U and V, V and W, and W and U phases of the motor connector (with five core wire) and check that each phase are balanced (within a permissible dispersion range of  $\pm 20\%$ ).
- \*2. Measurement of signal wire connector.  
Remove the connector and measure the resistance between GND and Vcc, Hw, Hv, or Hu terminals of the motor connector (with five core wire).

Connector power wire use

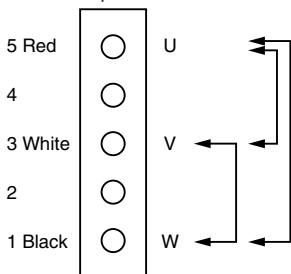

Connector signal wire use

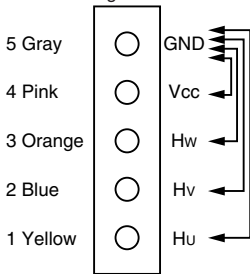

## Remote Controller Display



### Applicable Models

R-22: FXM200, 250L

R-410A: FXMQ-MA

### Method of Error Detection

This error is detected by detecting that the individual power supply for the fan turns OFF.

### Error Decision Conditions

When it is not detected that the individual power supply for the indoor unit fan turns ON while in operation.

### Supposed Causes

- Defective power supply for the indoor unit fan motor
- Clogged drain piping
- Actuation of the indoor unit safety device
- Defective contact in the fan wiring circuit

## Troubleshooting



### Caution

Be sure to turn off the power switch before connecting or disconnecting connectors, or parts may be damaged.

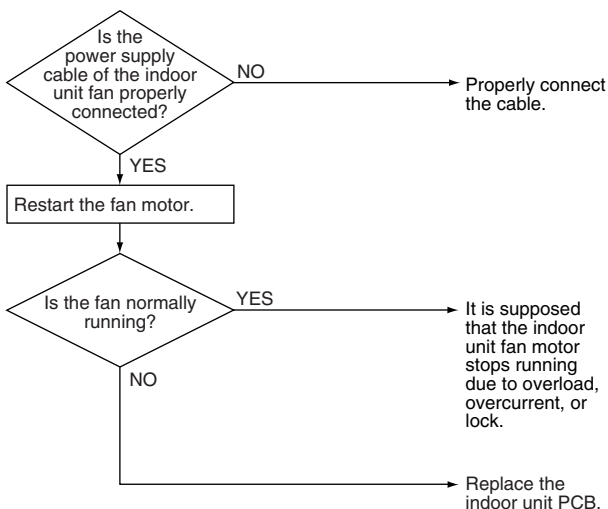

## 3.7 87 Swing Flap Motor (M1S) Abnormality

### Remote Controller Display

87

### Applicable Models

R-22: FXC, FXA, FXF, FXH, FXK

R-410A: FXCQ, FXHQ, FXKQ, FXUQ

### Method of Error Detection

Utilizes ON/OFF of the limit switch when the motor turns.

### Error Decision Conditions

When ON/OFF of the micro-switch for positioning cannot be reversed even though the swing flap motor is energized for a specified amount of time (about 30 seconds).

- \* Error code is displayed but the system operates continuously.

### Supposed Causes

- Defective swing motor
- Defective connection cable (power supply and limit switch)
- Defective airflow direction adjusting flap-cam
- Defective indoor unit PCB

## Troubleshooting



### Caution

Be sure to turn off the power switch before connecting or disconnecting connectors, or parts may be damaged.

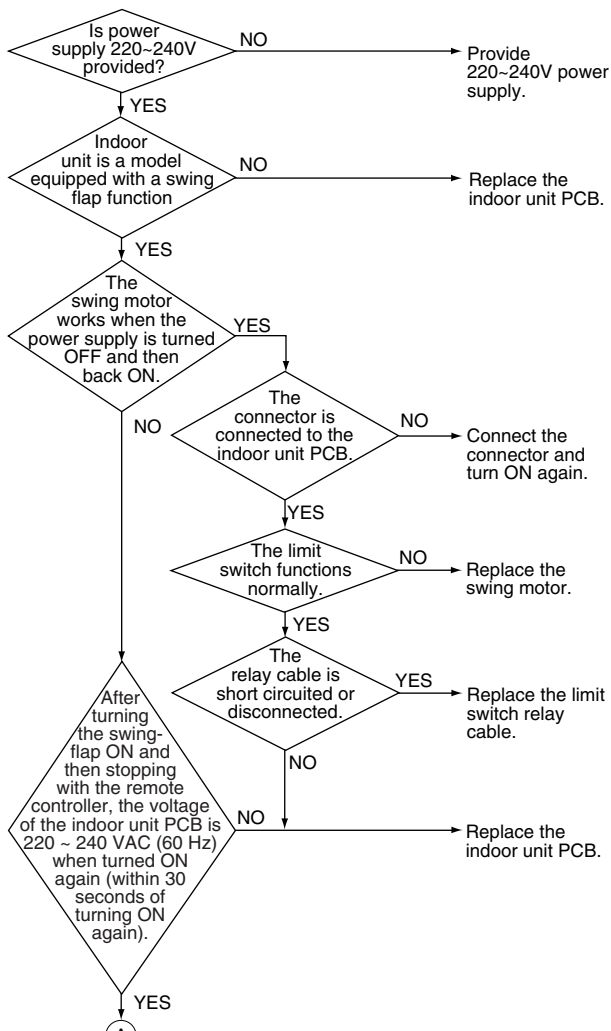

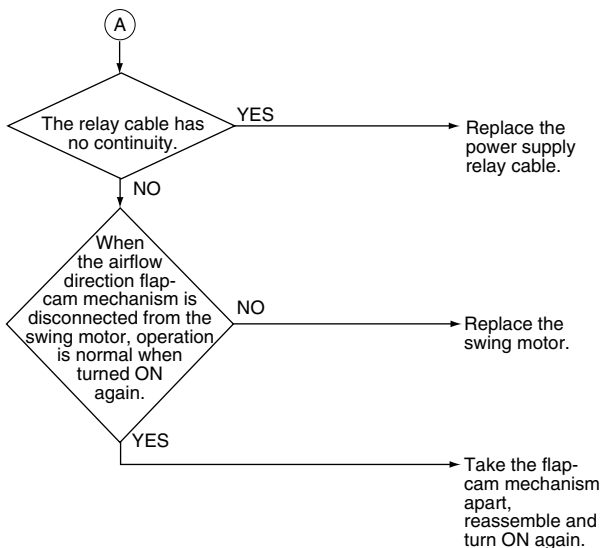

## 3.8 **88** Power Supply Voltage Abnormality

### Remote Controller Display

**88**

### Applicable Models

FXMQ20~140P

### Method of Error Detection

Detect error checking the input voltage of fan motor.

### Error Decision Conditions

When the input voltage of fan motor is 150V or less, or 386V or more.

### Supposed Causes

- Defective power supply voltage.
- Defective connection on signal line.
- Defective wiring.
- Instantaneous blackout, others.

## Troubleshooting



### Caution

Be sure to turn off the power switch before connecting or disconnecting connectors, or parts may be damaged.

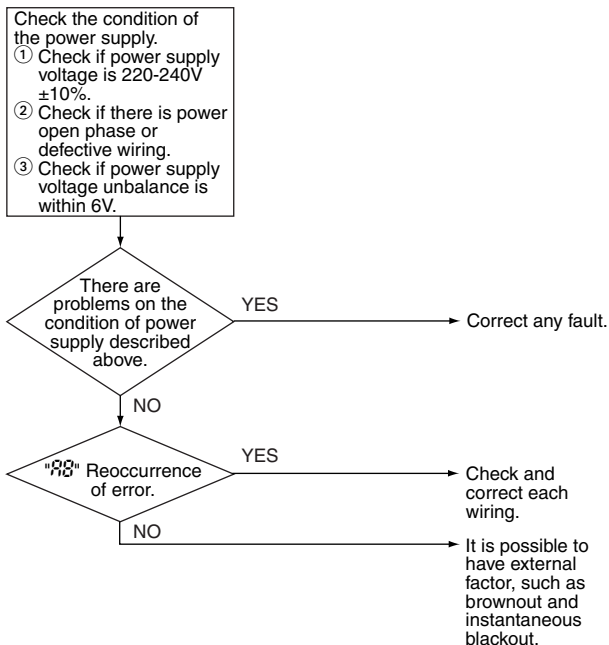



## 3.9 **89** Electronic Expansion Valve Coil Abnormality / Dust Clogging

### Remote Controller Display

**89**

### Applicable Models

All indoor models

### Method of Error Detection

Check the coil condition of electronic expansion valve by using micro-computer.

Check the dust clogging condition of electronic expansion valve main body by using micro-computer.

### Error Decision Conditions

Pin input for electronic expansion valve coil is abnormal when initializing micro-computer.

Either of the following conditions is seen/caused/ occurs while the unit stops operation.

- Temperature of suction air – temperature of liquid pipe of heat exchanger > 8°C.
- Temperature of liquid pipe of heat exchanger shows fixed degrees or below.

### Supposed Causes

- Defective electronic expansion valve coil
- Defective PCB indoor unit
- Defective relay cables

## Troubleshooting



### Caution

Be sure to turn off the power switch before connecting or disconnecting connectors, or parts may be damaged.

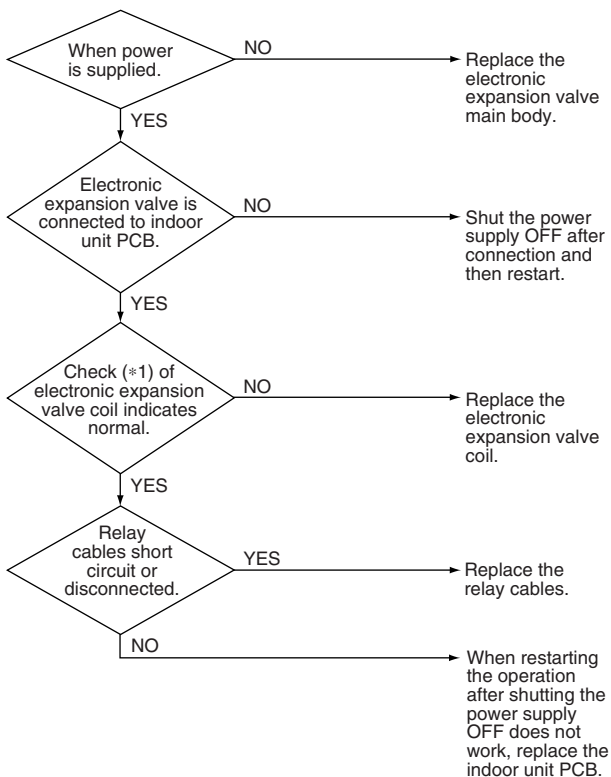

**i** Note:

- \*1: How to check the electronic expansion valve coil  
 Remove the connector for electronic expansion valve from PCB. Measure the resistance value between pins and check the continuity to judge the condition.

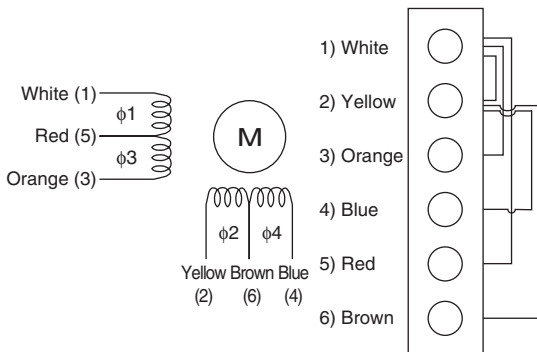

The normal products will show the following conditions:

- ① No continuity between (1) and (2)
- ② Resistance value between (1) and (3) is approx. 300  $\Omega$
- ③ Resistance value between (1) and (5) is approx. 150  $\Omega$
- ④ Resistance value between (2) and (4) is approx. 300  $\Omega$
- ⑤ Resistance value between (2) and (6) is approx. 150  $\Omega$

## 3.10 Drain Level above Limit

### Remote Controller Display



### Applicable Models

R-22: FXF, FXC, FXK, FXS, FXM, FXYB

R-410A: FXFQ, FXZQ, FXCQ, FXKQ, FXDQ, FXMQ,  
FXHQ, FXUQ

### Method of Error Detection

Water leakage is detected based on float switch ON/OFF operation while the compressor is in non-operation.

### Error Decision Conditions

When the float switch changes from ON to OFF while the compressor is in non-operation.

- \* Error code is displayed but the system operates continuously.

### Supposed Causes

- Humidifier unit (optional accessory) leaking
- Defective drain piping (upward slope, etc.)
- Defective indoor unit PCB

## Troubleshooting



### Caution

Be sure to turn off the power switch before connecting or disconnecting connectors, or parts may be damaged.

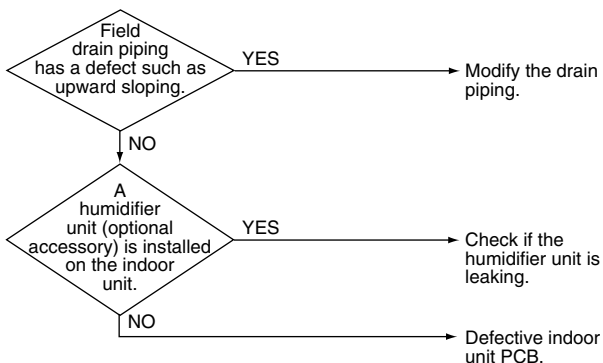

## 3.11 Capacity Determination Device Abnormality

### Remote controller display



### Applicable Models

All indoor models

### Method of Error Detection

Capacity is determined according to resistance of the capacity setting adaptor and the memory inside the IC memory on the indoor unit PCB, and whether the value is normal or abnormal is determined.

### Error Decision Conditions

When the capacity code is not saved to the PCB, and the capacity setting adaptor is not connected.

When a capacity that does not exist for that unit is set.

### Supposed Causes

- The capacity setting adaptor was not installed.
- Defective indoor unit PCB

## Troubleshooting



### Caution

Be sure to turn off the power switch before connecting or disconnecting connectors, or parts may be damaged.

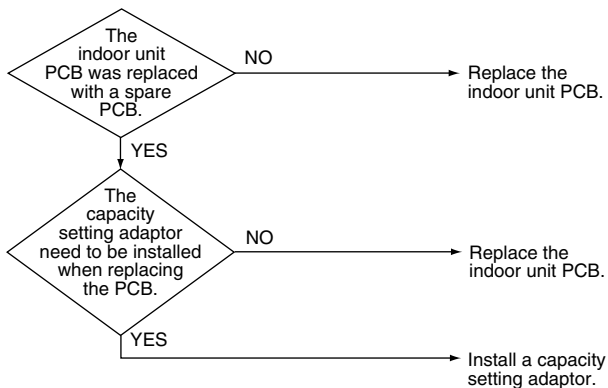

## 3.12 [ I Transmission Error (between Indoor unit PCB and Fan PCB)

### Remote Controller Display



### Applicable Models

FXMQ20~140P

### Method of Error Detection

Check the condition of transmission between indoor unit PCB and fan PCB using micro-computer.

### Error Decision Conditions

When normal transmission is not carried out for certain duration.

### Supposed Causes

- Defective connection of the connector between indoor unit PCB and fan PCB
- Defective indoor unit PCB
- Defective fan PCB
- External factor, such as instantaneous blackout



## Troubleshooting



### Caution

Be sure to turn off the power switch before connecting or disconnecting connectors, or parts may be damaged.

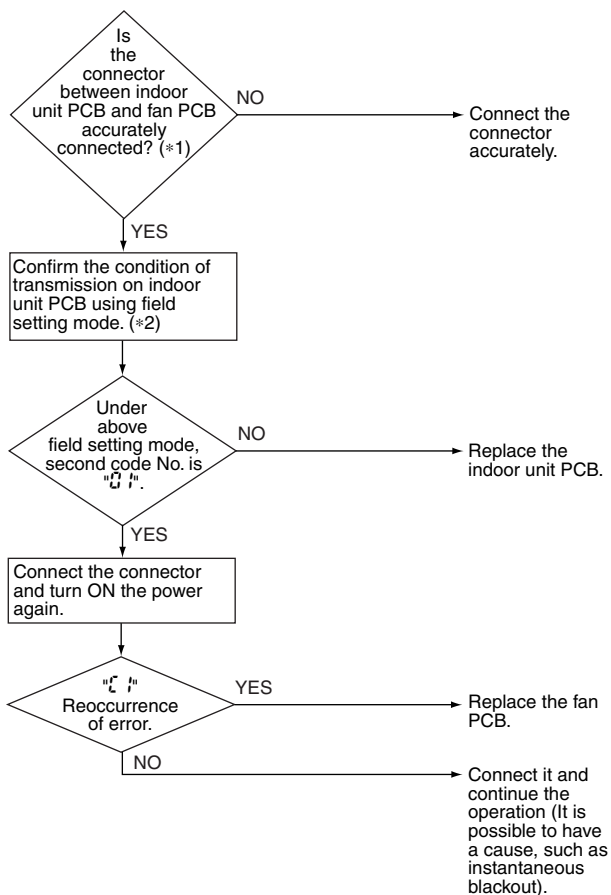



**Note:**

- \*1. Pull out and insert the connector once and check it is absolutely connected.
- \*2. Method to check transmission part of indoor unit PCB.
  - ① Turn OFF the power and remove the connector of indoor unit PCB.
  - ② Short circuit the connector.
  - ③ After turning ON the power, check below numbers under field setting from remote controller.  
(Confirmation: Second code No. at the condition of first code No. 21 on mode No. 41)



Determination	01: Normal
	Other than 01: Transmission error on indoor unit PCB

- \* After confirmation, turn OFF the power, take OFF the short circuit and connect the connector back to original condition.

## 3.13 E4 Thermistor for Liquid Pipe Abnormality

### Remote Controller Display

E4

### Applicable Models

All indoor models

### Method of Error Detection

Error detection is carried out by temperature detected by liquid pipe thermistor.

### Error Decision Conditions

When the liquid pipe thermistor becomes disconnected or shorted while the unit is running

### Supposed Causes

- Defective thermistor for liquid pipe
- Defective indoor unit PCB

## Troubleshooting



### Caution

Be sure to turn off the power switch before connecting or disconnecting connectors, or parts may be damaged.

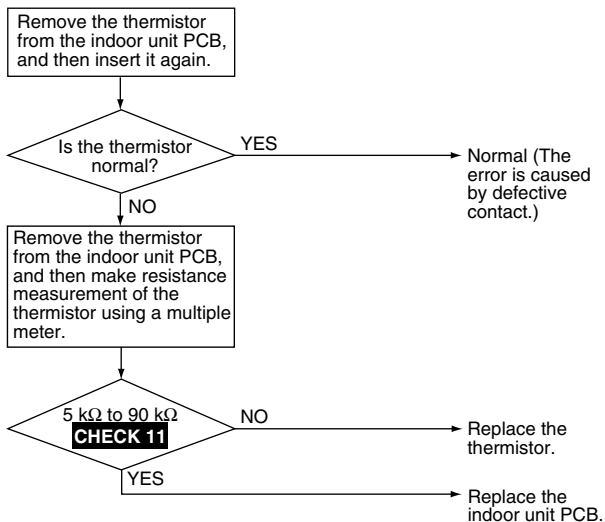

**CHECK 11** Refer to P.369.

## 3.14 E5 Thermistor for Gas Pipe Abnormality

### Remote Controller Display

E5

### Applicable Models

All indoor models

### Method of Error Detection

Error detection is carried out by temperature detected by gas pipe thermistor.

### Error Decision Conditions

When the gas pipe thermistor becomes disconnected or shorted while the unit is running

### Supposed Causes

- Defective thermistor for gas pipe
- Defective indoor unit PCB

## Troubleshooting



### Caution

Be sure to turn off the power switch before connecting or disconnecting connectors, or parts may be damaged.

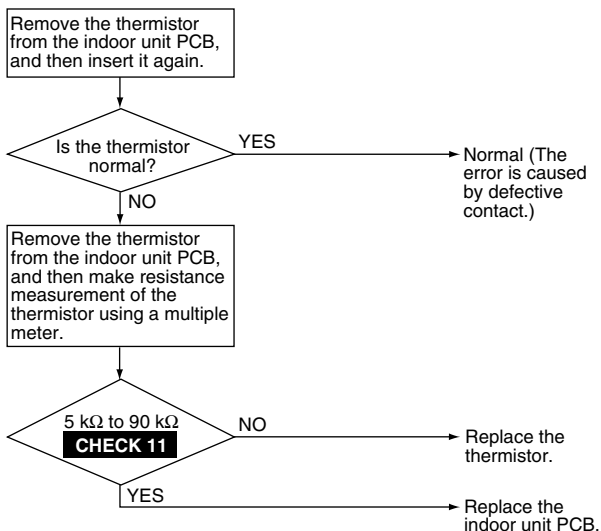

**CHECK 11** Refer to P.369.

## 3.15 E6 Combination Abnormality (between Indoor unit PCB and Fan PCB)

### Remote Controller Display

E6

### Applicable Models

FXMQ20~140P

### Method of Error Detection

Check the condition of transmission with fan PCB using indoor unit PCB.

### Error Decision Conditions

When the communication data of fan PCB is determined as incorrect

### Supposed Causes

- Defective fan PCB.
- Defective connection of capacity setting adaptor
- Field setting error.

## Troubleshooting



### Caution

Be sure to turn off the power switch before connecting or disconnecting connectors, or parts may be damaged.

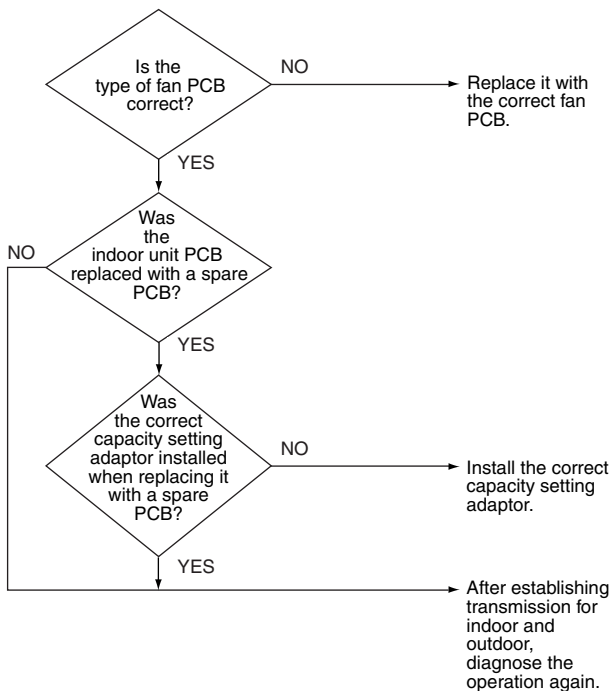



## 3.16 E9 Thermistor for Suction Air Abnormality

### Remote Controller Display

E9

### Applicable Models

All indoor models

### Method of Error Detection

Error detection is carried out by temperature detected by suction air thermistor.

### Error Decision Conditions

When the suction air thermistor becomes disconnected or shorted while the unit is running

### Supposed Causes

- Defective thermistor for suction air
- Defective indoor unit PCB

## Troubleshooting



### Caution

Be sure to turn off the power switch before connecting or disconnecting connectors, or parts may be damaged.

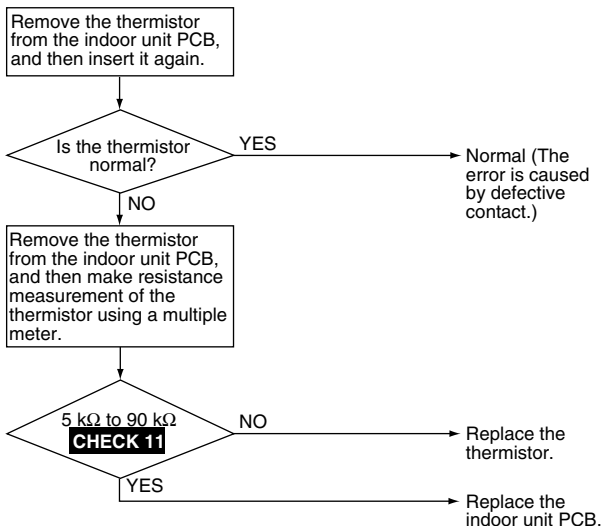

**CHECK 11** Refer to P.369.

## 3.17 Thermistor for Discharge Air Abnormality

### Remote Controller Display



### Applicable Models

All indoor models

### Method of Error Detection

Error detection is carried out by temperature detected by discharge air temperature thermistor.

### Error Decision Conditions

When the discharge air temperature thermistor becomes disconnected or shorted while the unit is running.

### Supposed Causes

- Defective indoor unit thermistor for air outlet
- Defective indoor unit PCB

## Troubleshooting



**Caution**

Be sure to turn off the power switch before connecting or disconnecting connectors, or parts may be damaged.

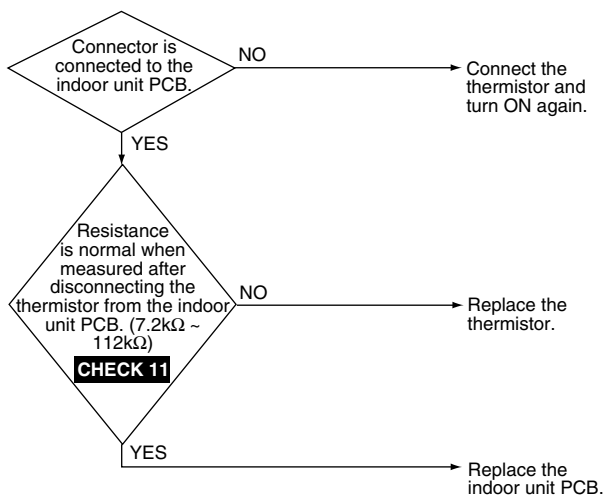

**CHECK 11** Refer to P.369.

## 3.18 Humidity Sensor System Abnormality

### Remote Controller Display



### Applicable Models

FXFQ

### Method of Error Detection

Even if an error occurs, operation still continues.  
Error is detected according to the moisture (output voltage) detected by the moisture sensor.

### Error Decision Conditions

When the moisture sensor is disconnected or short circuited

### Supposed Causes

- Defective sensor
- Disconnection

## Troubleshooting



### Caution

Be sure to turn off the power switch before connecting or disconnecting connectors, or parts may be damaged.

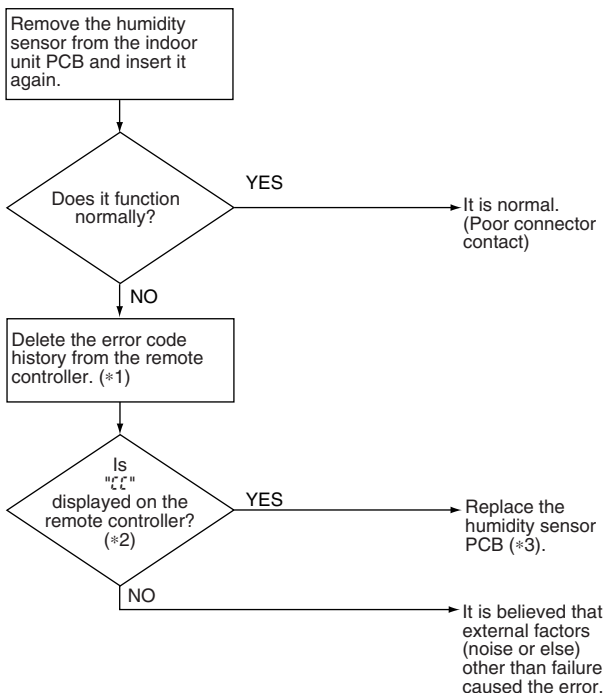

### Note:

- \*1. To delete the history, the **ON/OFF** button of the remote controller must be pressed and held for 5 seconds in the check mode.
- \*2. To display the code, the **Inspection/Test Operation** button of the remote controller must be pressed and held in the normal mode.
- \*3. If "E1" is displayed even after replacing the humidity sensor PCB assy and taking the steps \*1 and \*2,

## 3.19 Room Temperature Thermistor in Remote Controller Abnormality

### Remote Controller Display



### Applicable Models

All indoor models

### Method of Error Detection

Error detection is carried out by temperature detected by room temperature thermistor in remote controller.

### Error Decision Conditions

When the room temperature thermistor in remote controller becomes disconnected or shorted while the unit is running.

\* Error code is displayed but the system operates continuously.

### Supposed Causes

- Defective room temperature thermistor in remote controller
- Defective remote controller PCB

## Troubleshooting



### Caution

Be sure to turn off the power switch before connecting or disconnecting connectors, or parts may be damaged.

Clear the error code history. (\*1) (While in inspection mode, press and hold the "ON/OFF" button for a period of 4 seconds or more.)

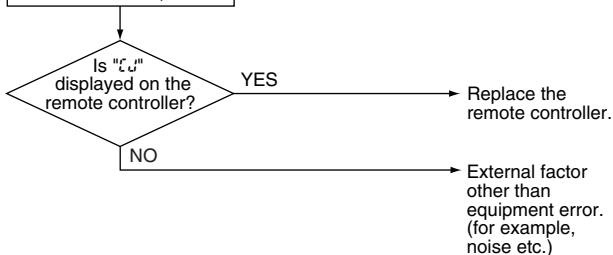

### Note:

- \*1. How to delete "history of error codes". Press the **ON/OFF** button for 4 seconds and more while the error code is displayed in the inspection mode.



## 3.20 E1 PCB Abnormality

### Remote Controller Display

E1

### Applicable Models

All outdoor unit models

### Method of Error Detection

Abnormality is detected under the communication conditions in the hardware section between the indoor unit and outdoor unit.

### Error Decision Conditions

When the communication conditions in the hardware section between the indoor unit and the outdoor unit are not normal

### Supposed Causes

- Defective outdoor unit main PCB
- Defective connection of inside/outside relay wires

## Troubleshooting



### Caution

Be sure to turn off the power switch before connecting or disconnecting connectors, or parts may be damaged.

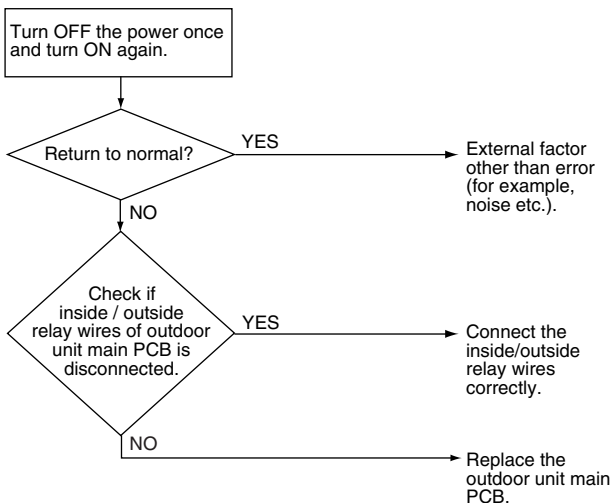

## 3.21 E2 Earth Leakage by Leak Detection PCB Assy

### Remote Controller Display

E2

### Applicable Models

VRV-WII, -WIII, III and III-Q Series

### Method of Error Detection

Failure is to be detected by using leak detection PCB Assy.

### Error Decision Conditions

Leakage is detected under the conditions outside of the scope of high pressure switch operation.

### Supposed Causes

- Defective compressor

## Troubleshooting



### Caution

Be sure to turn off the power switch before connecting or disconnecting connectors, or parts may be damaged.

Turn OFF the power supply, and then disconnect compressor lead wire.

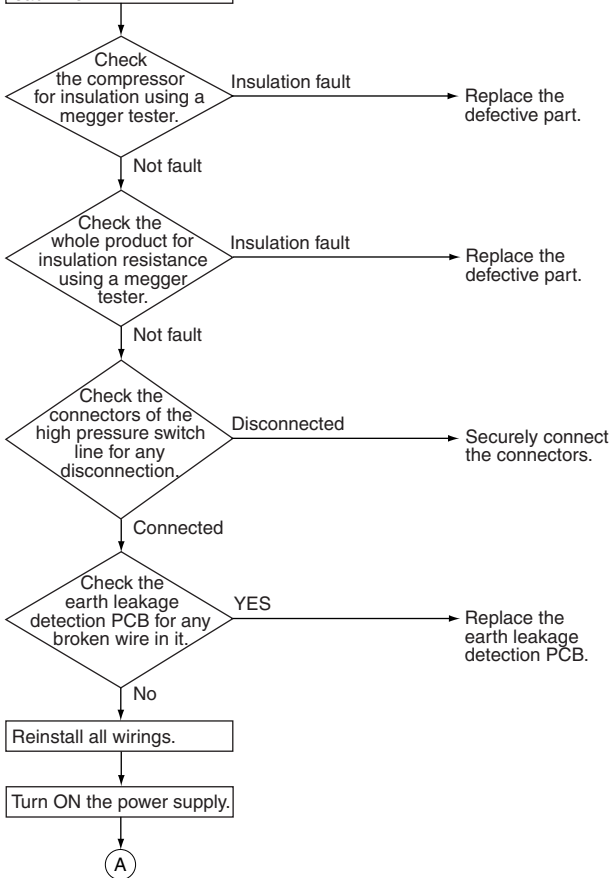

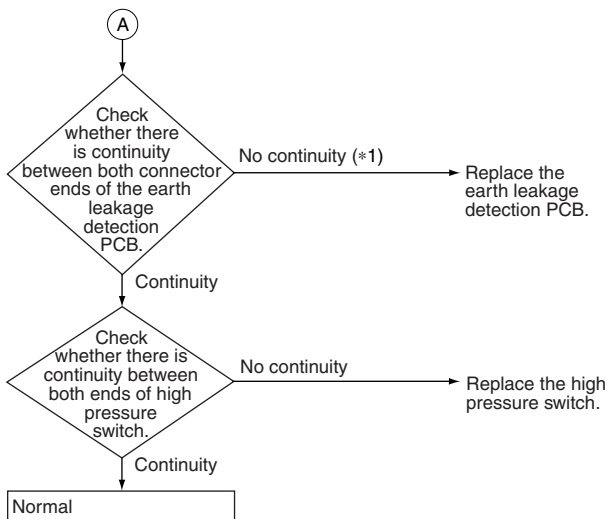

It is supposed that ground leakage occurs due to temporary liquid back or accumulation of refrigerant. This phenomenon can occur when power fails while in operation or is cut off for an extended period of time.

**i** Note:

- \*1. It is normal that there is no continuity between both ends of connector when the power supply turns OFF and for a period of 9 seconds at maximum after the power supply turns ON.

## 3.22 E3 Actuation of High Pressure Sensor

### Remote Controller Display

E3

### Applicable Models

VRVII and II-S Series

### Method of Error Detection

Abnormality is detected when the contact of the high pressure protection switch opens.

### Error Decision Conditions

Error is generated when the high pressure switch activation count reaches the number specific to the operation mode.

### Supposed Causes

- Actuation of outdoor unit high pressure switch
- Defective high pressure switch
- Defective outdoor unit PCB
- Instantaneous power failure
- Defective high pressure sensor

## Troubleshooting



**Caution**

Be sure to turn off the power switch before connecting or disconnecting connectors, or parts may be damaged.

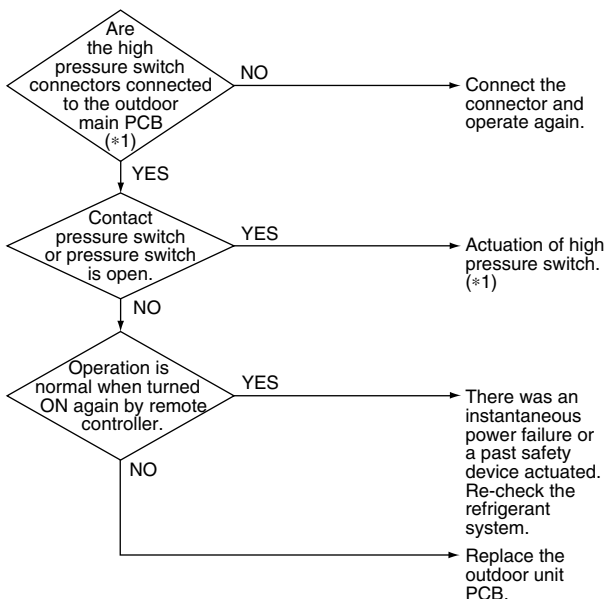

**Note:**

- \*1. Actuation of high pressure switch
- The outdoor unit PCB connector is disconnected.
  - Is the outdoor unit heat exchanger dirty?
  - Defective outdoor unit fan
  - Is the refrigerant overcharged?
  - Defective high pressure sensor

## 3.23 E3 Abnormal Discharge Pressure

### Remote Controller Display

E3

### Applicable Models

VRV-WII, -WIII, III, III-S and III-Q Series

### Method of Error Detection

Abnormality is detected when the contact of the high pressure protection switch opens.

### Error Decision Conditions

Error is generated when the high pressure switch activation count reaches the number specific to the operation mode.

### Supposed Causes

- Actuation of high pressure switch
- Defective high pressure switch
- Defective outdoor unit main PCB
- Instantaneous power failure
- Defective high pressure sensor



## Troubleshooting



### Caution

Be sure to turn off the power switch before connecting or disconnecting connectors, or parts may be damaged.

Check for the points shown below.

- ① Is the stop valve open?
- ② Is the high pressure switch connector properly connected to the main PCB?
- ③ Is there continuity with the high pressure switch?

Are the 3 points above OK?

NO

Rectify the defective points, if any.

YES

- ① Mount a pressure gauge on the high pressure service port.
- ② Reset the operation using the remote controller, and then restart the operation.

Does the abnormal stop "E 3" recur?

YES

Is the high pressure switch operating value normal?

NO

Replace the high pressure switch.

YES

NO

Are the characteristics of the high pressure sensor normal? (\*1)

NO

Replace the high pressure sensor.

YES

### Service Checker

Connect the service checker to compare the "high pressure" value checked with the Service Checker and the actual measurement value by pressure sensor (\*1).

A

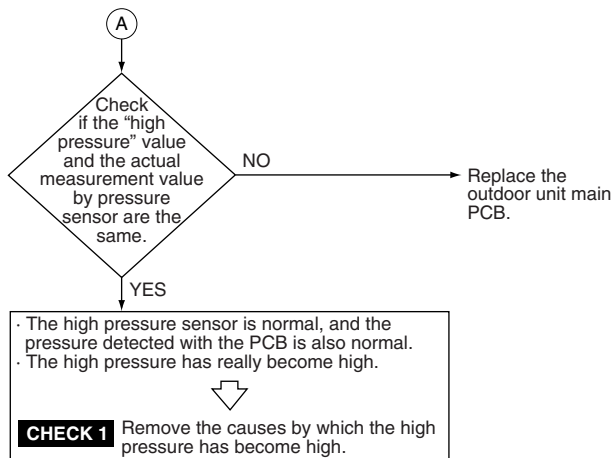

**i Note:**

- \*1. Make a comparison between the voltage of the pressure sensor and that read by the pressure gauge. (As to the voltage of the pressure sensor, make measurement of voltage at the connector, and then convert it to pressure. **CHECK 12** )
- \*2: Make measurement of voltage of the pressure sensor.

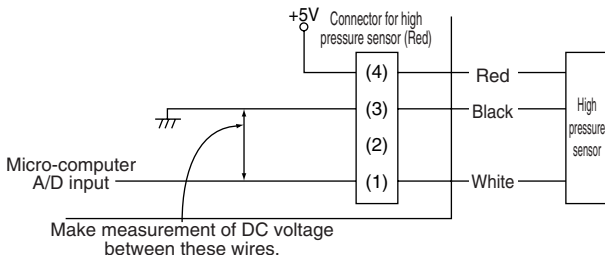

**➔ CHECK 1 Refer to P.346.**

## 3.24 E4 Actuation of Low Pressure Sensor

### Remote Controller Display

E4

### Applicable Models

VRVII and II-S Series

### Method of Error Detection

### Error Decision Conditions

Error is generated when the low pressure is dropped under specific pressure.

### Supposed Causes

- Abnormal drop of low pressure
- Defective low pressure sensor
- Defective outdoor unit PCB
- Stop valve is not opened.

## Troubleshooting



### Caution

Be sure to turn off the power switch before connecting or disconnecting connectors, or parts may be damaged.

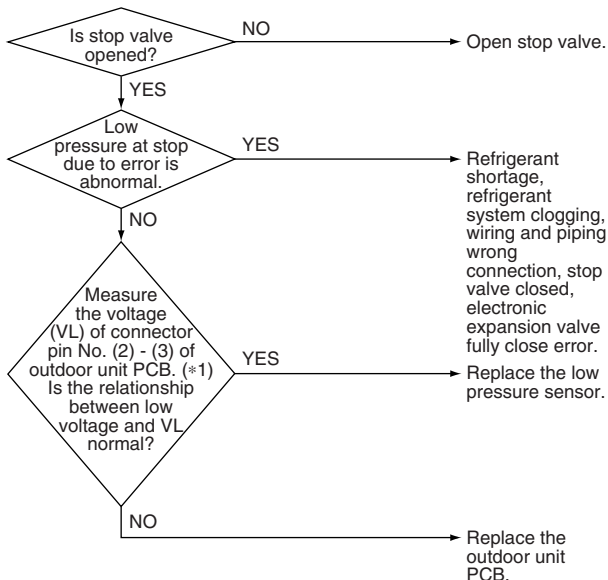

### Note:

- \*1. Make measurement of voltage of the pressure sensor.

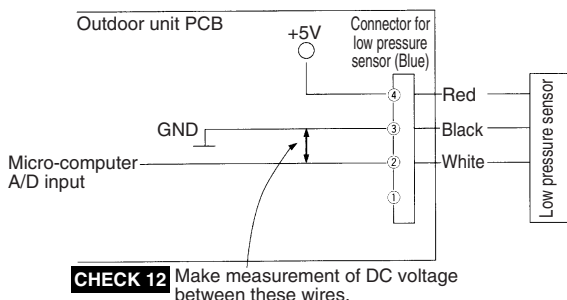

## 3.25 E4 Abnormal Suction Pressure

### Remote Controller Display

E4

### Applicable Models

VRV-WII, -WIII, III, III-S and III-Q Series

### Method of Error Detection

Abnormality is detected by the pressure value with the low pressure sensor.

### Error Decision Conditions

Error is generated when the low pressure drops while the compressor is in operation.

### Supposed Causes

- Abnormal drop of low pressure
- Defective low pressure sensor
- Defective outdoor unit PCB
- Stop valve is not opened.
- Clogged filter

## Troubleshooting



### Caution

Be sure to turn off the power switch before connecting or disconnecting connectors, or parts may be damaged.

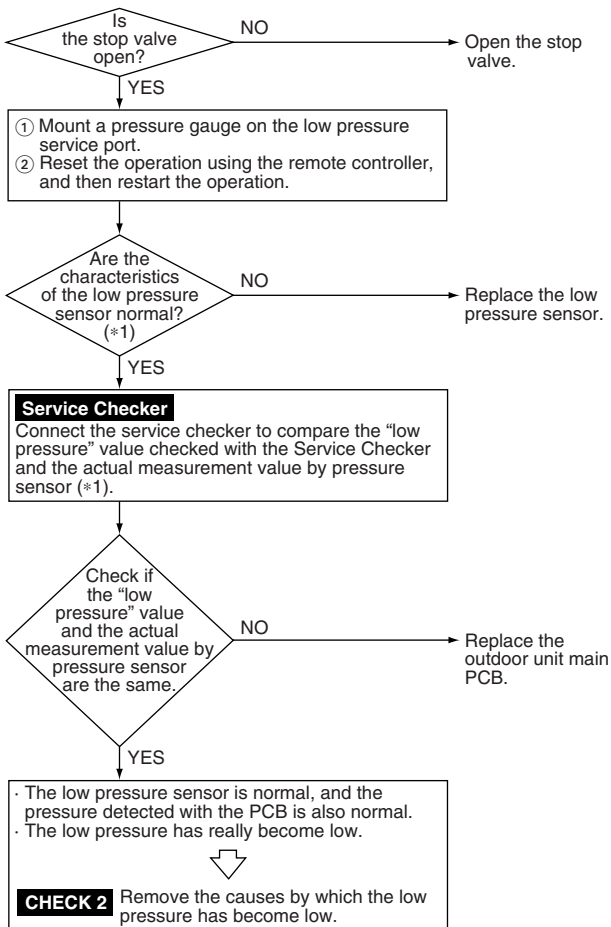

**i** Note:

- \*1. Make a comparison between the voltage of the pressure sensor and that read by the pressure gauge.  
(As to the voltage of the pressure sensor, make measurement of voltage at the connector, and then convert it to pressure. **CHECK 12** )
- \*2. Make measurement of voltage of the pressure sensor.

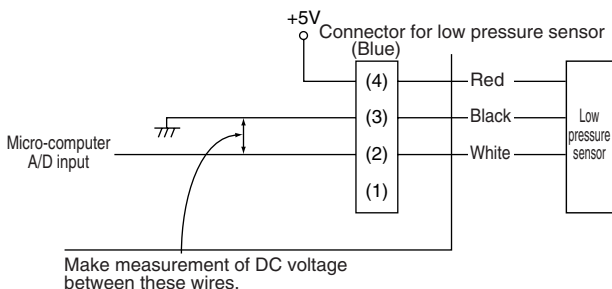

**↩** **CHECK 2** Refer to P.348.

**↩** **CHECK 12** Refer to P.372.

## 3.26 E5 Inverter Compressor Motor Lock

### Remote Controller Display

E5

### Applicable Models

VRVII and II-S Series

### Method of Error Detection

Inverter PCB takes the position signal from UVWN line connected between the inverter and compressor, and detects the position signal pattern.

### Error Decision Conditions

The position signal with 3 times cycle as imposed frequency is detected when compressor motor operates normally, but 2 times cycle when compressor motor locks. When the position signal in 2 times cycle is detected.

### Supposed Causes

- Compressor lock
- High differential pressure
- Incorrect UVWN wiring
- Defective inverter PCB
- Stop valve is not opened



## Troubleshooting



### Caution

Be sure to turn off the power switch before connecting or disconnecting connectors, or parts may be damaged.

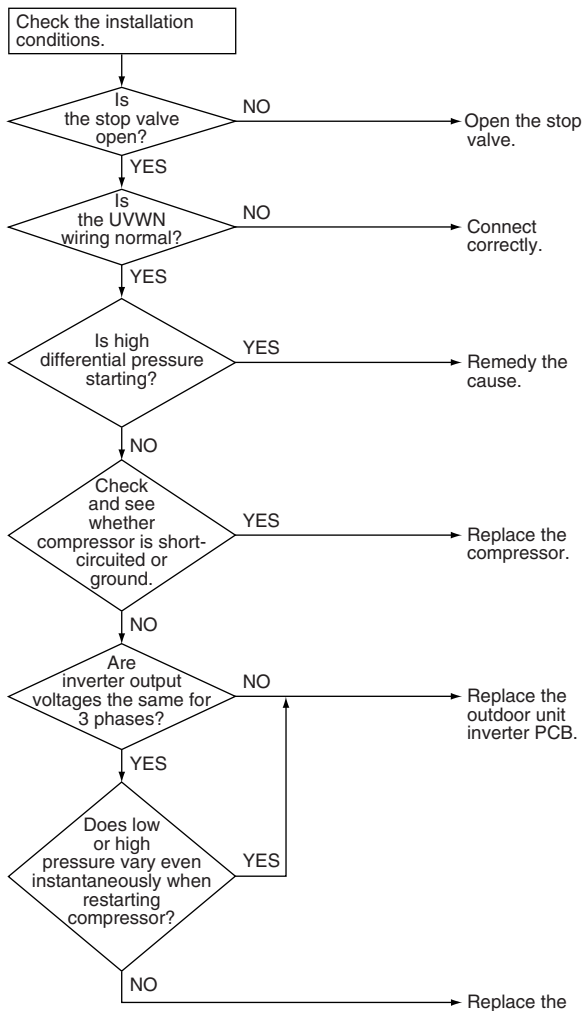

## Remote Controller Display

**E5**

### Applicable Models

VRVIII, III-S and III-Q Series

### Method of Error Detection

Inverter PCB takes the position signal from UVW line connected between the inverter and compressor, and the error is detected when any abnormality is observed in the phase-current waveform.

### Error Decision Conditions

This error will be output when the inverter compressor motor does not start up even in forced startup mode.

### Supposed Causes

- Inverter compressor lock
- High differential pressure
- Incorrect UVW wiring
- Defective inverter PCB
- Stop valve is not opened.

## Troubleshooting



### Caution

Be sure to turn off the power switch before connecting or disconnecting connectors, or parts may be damaged.

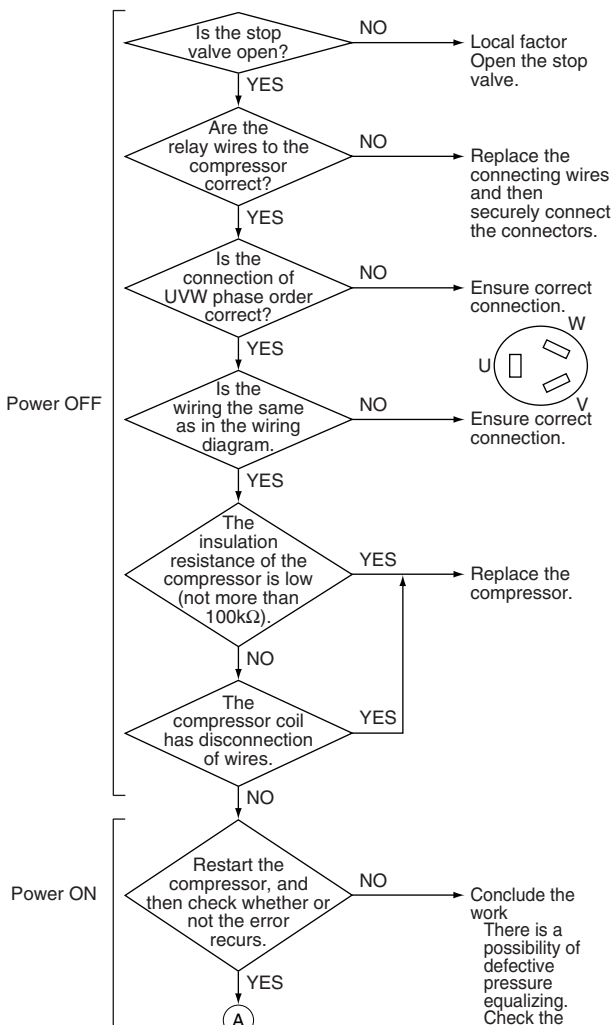

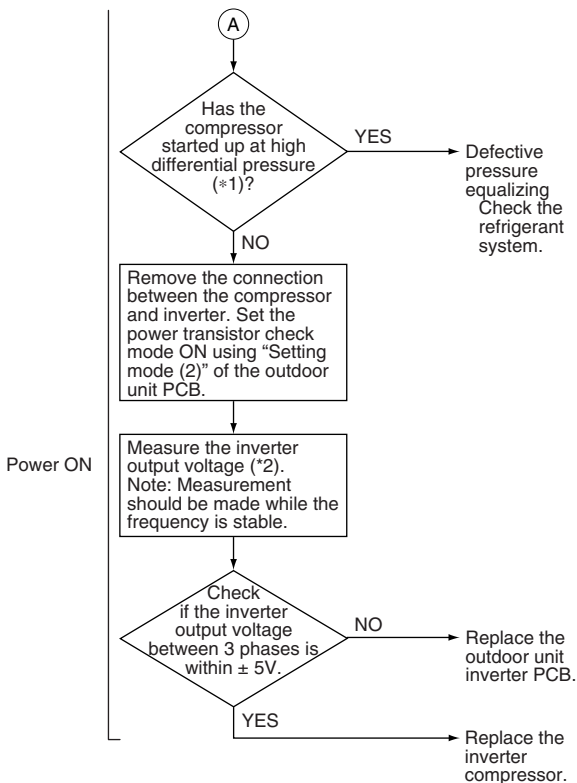

## Note:

- \*1. Pressure difference between high pressure and low pressure before starting.
- \*2. The quality of power transistors/diode modules can be judged by executing **CHECK 4**.



**CHECK 4** Refer to P.354.

## Remote Controller Display

**E5**

### Applicable Models

VRV-WII and -WIII Series

### Method of Error Detection

Pick up the location signal using the inverter PCB from the UVWN line connected between the inverter and the compressor and detect location signal pattern.

### Error Decision Conditions

In normal operation, location signal for a triple cycle of frequency applied, while in locked operation, it is a double cycle, and they are detected.

(Retry twice/60 minutes)

### Supposed Causes

- Inverter compressor lock
- High differential pressure
- Incorrect UVWN wire connection
- Defective inverter PCB
- Stop valve is not opened

## Troubleshooting



### Caution

Be sure to turn off the power switch before connecting or disconnecting connectors, or parts may be damaged.

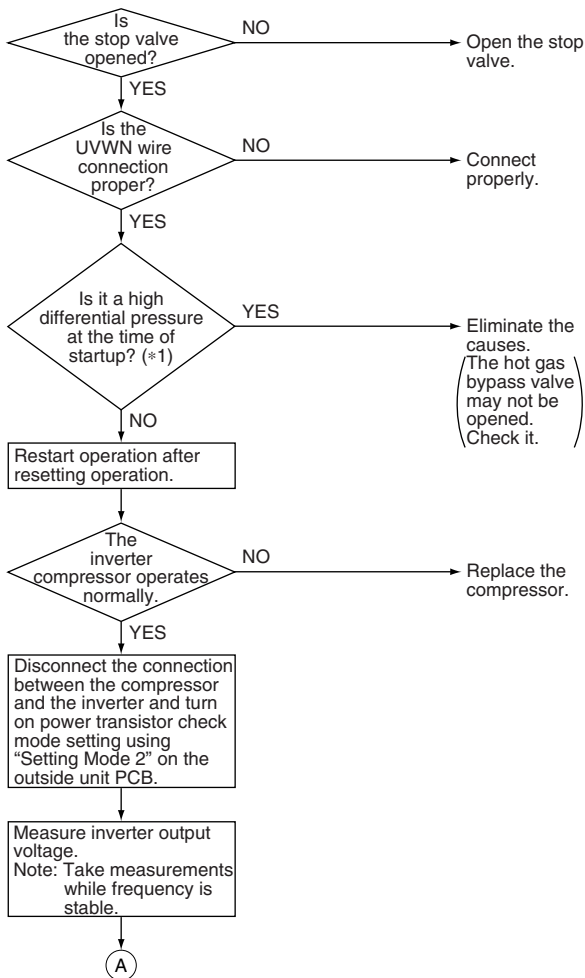

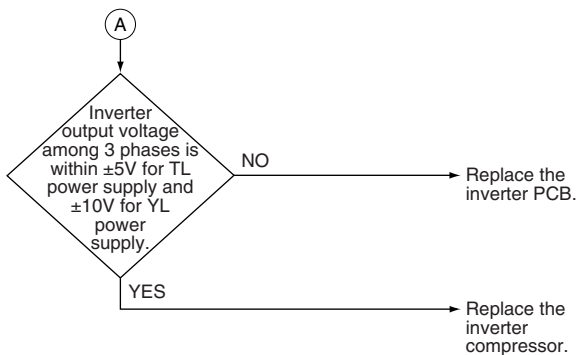

**Note:**

- \*1. Difference in pressure between high and low pressures before startup
- \*2. The quality of the power transistor diode module can be assessed also by means of measurement of resistance between terminals.

## 3.27 E6 STD Compressor Motor Overcurrent/Lock

### Remote Controller Display

E6

### Applicable Models

VRVII, III and III-Q Series

### Method of Error Detection

Detects the overcurrent with current sensor.

### Error Decision Conditions

Error is decided when the detected current value exceeds the below mentioned value for 2 seconds.

### Supposed Causes

- Stop valve is not opened
- Obstacles at the air outlet
- Improper power voltage
- Defective magnetic switch
- Defective compressor
- Defective current sensor



## Troubleshooting



### Caution

Be sure to turn off the power switch before connecting or disconnecting connectors, or parts may be damaged.

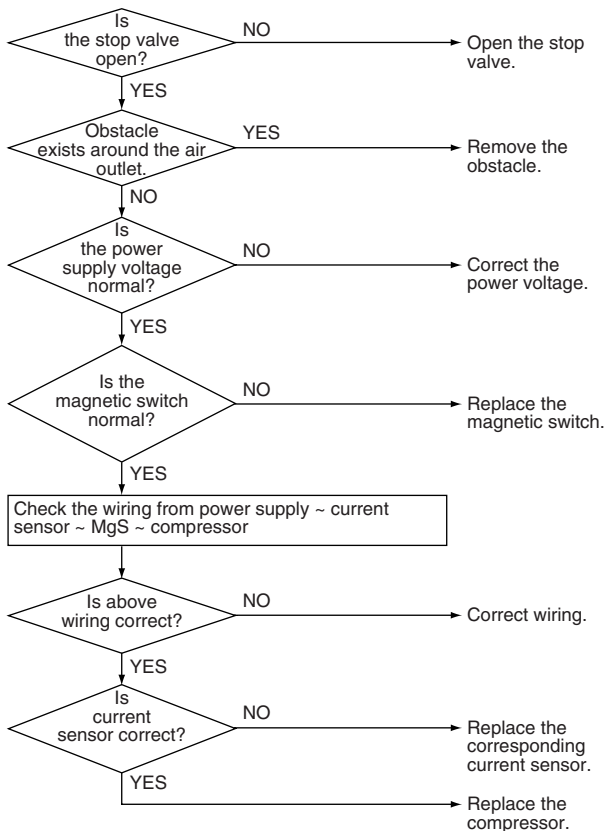

## 3.28 E7 Outdoor Unit Fan Motor Abnormality

### Remote Controller Display

E7

### Applicable Models

VRVIII and III-Q Series

### Method of Error Detection

Detect an error based on the current value in the inverter PCB (as for motor 2, current value in the fan PCB).

Detect an error for the fan motor circuit based on the number of rotation detected by hole IC during the fan motor operation.

### Error Decision Conditions

- Overcurrent is detected for inverter PCB or fan inverter PCB
- In the condition of fan motor rotation, the number of rotation is below the fixed number for more than 6 seconds.

### Supposed Causes

- Defective fan motor
- Defect or connection error of the connectors/ harness between the fan motor and PCB
- The fan can not rotate due to any foreign substances entangled.
- Clear condition: Continue normal operation for 5 minutes

## Troubleshooting



### Caution

Be sure to turn off the power switch before connecting or disconnecting connectors, or parts may be damaged.

#### Check in the monitor mode

Check fan motor (fan motor 1 or 2) corresponding to error code "E?" in the monitor mode of outdoor unit PCB.

Turn the power supply OFF and wait for 10 minutes.

Check if any foreign substances around the fan.

YES

Remove the foreign substances.

NO

#### Check the connection status of the connectors

- Fan motor 1: relay connector or connectors of compressor inverter PCB.
- Fan motor 2: relay connector or connectors of fan inverter PCB.

Check if any connector is disconnected.

YES

Insert the connector.

NO

#### Check the color of relay connectors

- Fan motor 1: Both power supply wire and signal wire are all white.
- Fan motor 2: Both power supply wire and signal wire are red in the PCB side and white in the motor side.

Relay connectors have any connection error.

YES

Correct the connection of the relay connectors.

NO

(A)

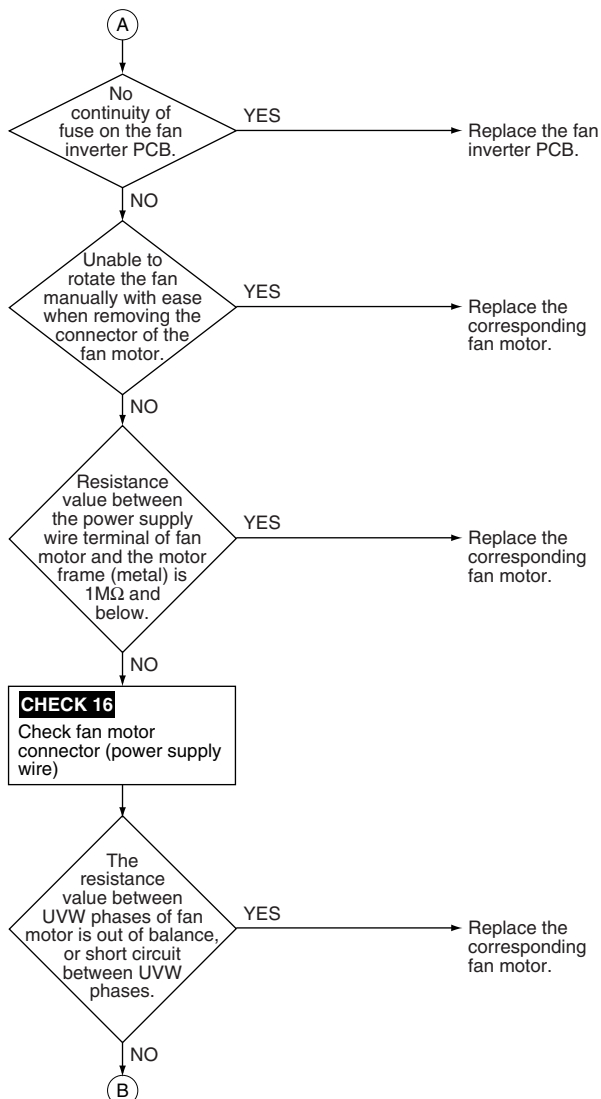

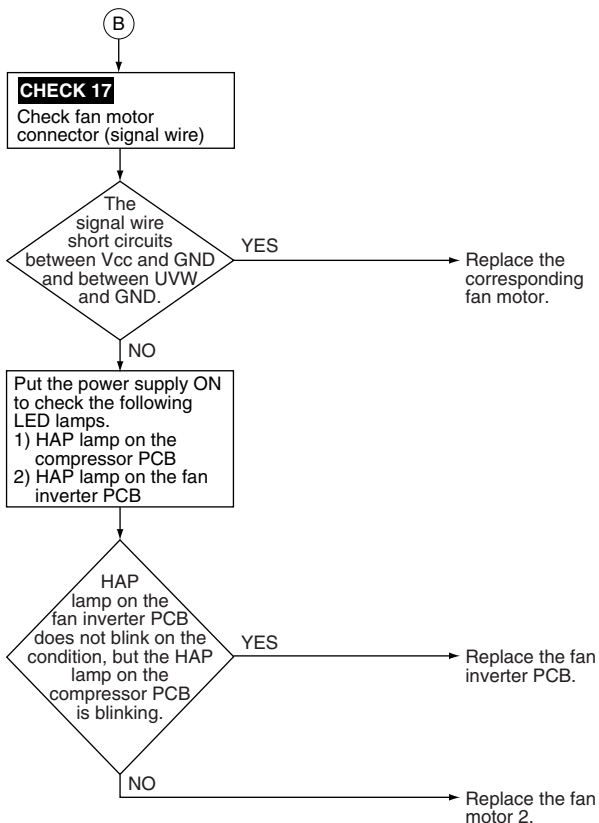

**CHECK 16** Refer to P.378.



**CHECK 17** Refer to P.379.

## Remote Controller Display

E7

### Applicable Models

VRVIII-S Series

### Method of Error Detection

Detect an error based on the current value in the inverter PCB (as for motor 2, current value in the fan PCB).

Detect an error for the fan motor circuit based on the number of rotation detected by hole IC during the fan motor operation.

### Error Decision Conditions

- Overcurrent is detected for inverter PCB or fan inverter PCB
- In the condition of fan motor rotation, the number of rotation is below the fixed number for more than 6 seconds.

### Supposed Causes

- Defective fan motor
- Defect or connect ion error of the connectors/ harness between the fan motor and PCB
- The fan can not rotate due to any foreign substances entangled.
- Clear condition: Continue normal operation for 5 minutes

## Troubleshooting



### Caution

Be sure to turn off the power switch before connecting or disconnecting connectors, or parts may be damaged.

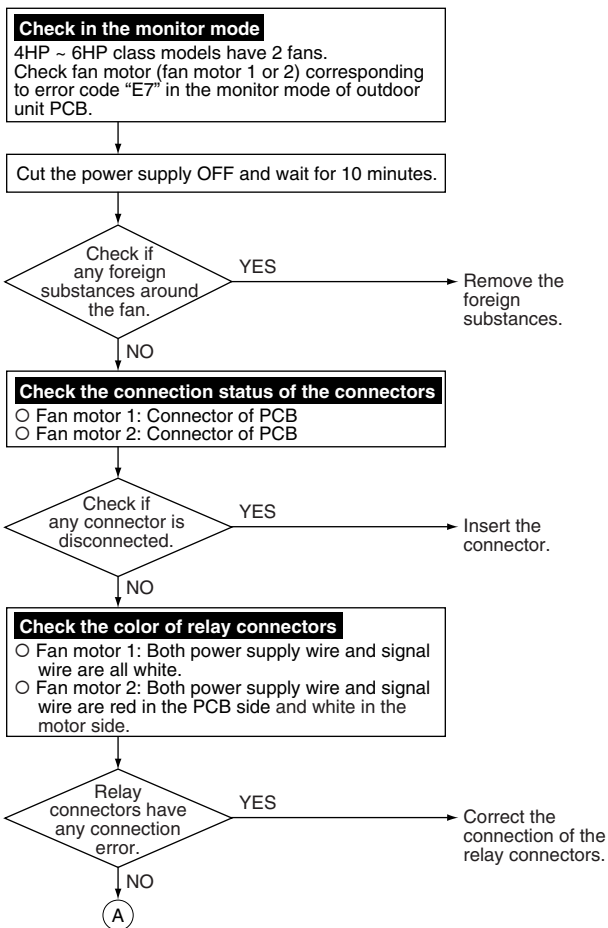

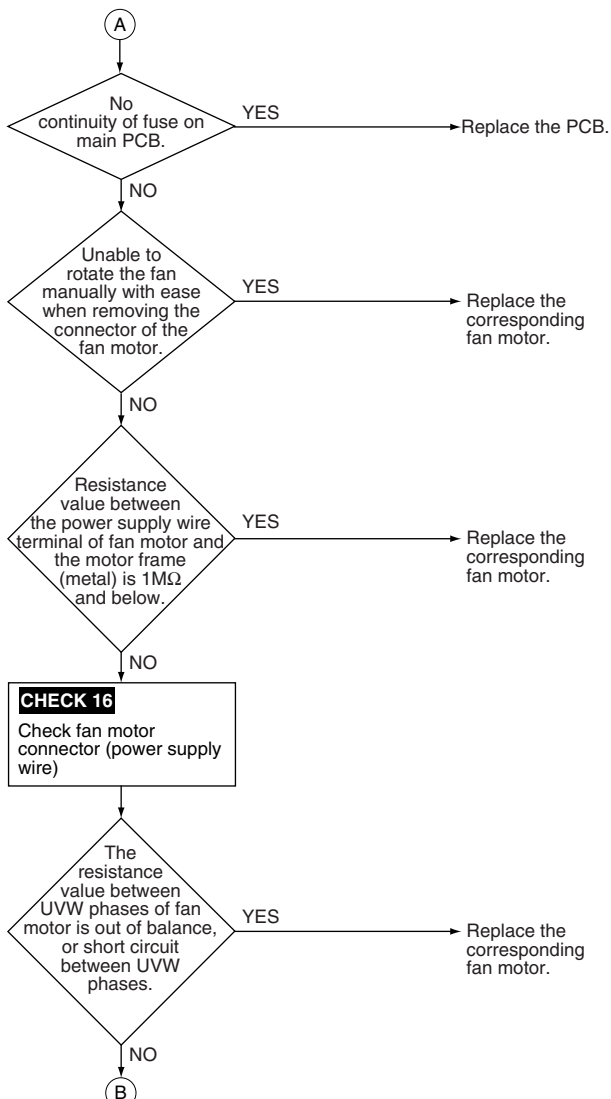



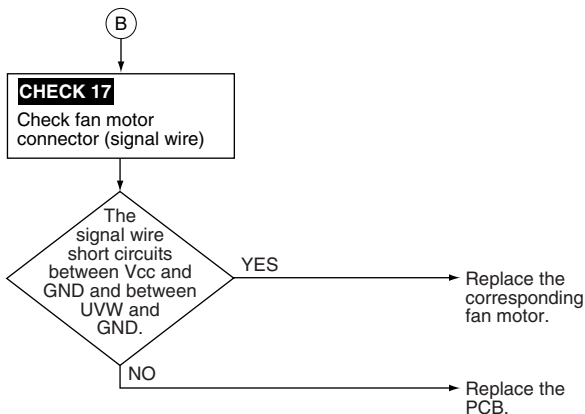

 **CHECK 16** Refer to P.378.

 **CHECK 17** Refer to P.379.

## Remote Controller Display

E7

### Applicable Models

VRVII-S Series

### Method of Error Detection

Error of fan motor system is detected according to the fan speed detected by hall IC when the fan motor runs.

### Error Decision Conditions

- When the fan runs with speed less than a specified one for 14.5 seconds or more when the fan motor running conditions are met
- When error is generated 4 times, the system shuts down.

### Supposed Causes

- Defective fan motor
- The harness connector between fan motor and PCB is left in disconnected, or defective connector
- Fan does not run due to foreign matters tangled
- Clearing condition: Operate for 5 minutes (normal)

## Troubleshooting



### Caution

Be sure to turn off the power switch before connecting or disconnecting connectors, or parts may be damaged.

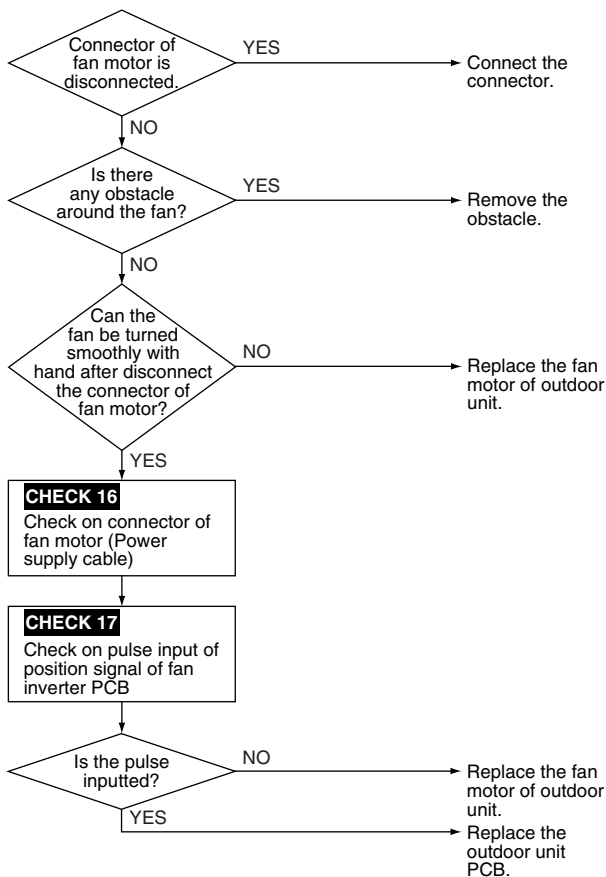

**CHECK 16** Refer to P.378.



**CHECK 17** Refer to P.379.

## Remote Controller Display

E7

### Applicable Models

VRVII Series

### Method of Error Detection

Error of fan motor system is detected according to the fan speed detected by hall IC when the fan motor runs.

### Error Decision Conditions

- When the fan runs with speed less than a specified one for 15 seconds or more when the fan motor running conditions are met
- When connector detecting fan speed is disconnected
- When error is generated 4 times, the system shuts down.

### Supposed Causes

- Defective fan motor
- The harness connector between fan motor and PCB is left in disconnected, or defective connector
- Fan does not run due to foreign matters tangled
- Clearing condition: Operate for 5 minutes (normal)

## Troubleshooting



### Caution

Be sure to turn off the power switch before connecting or disconnecting connectors, or parts may be damaged.

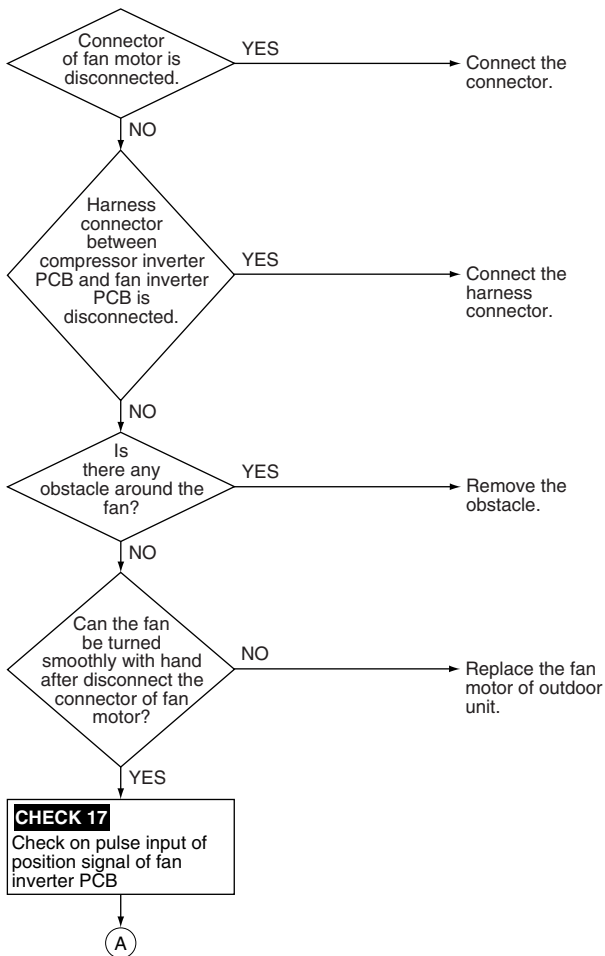

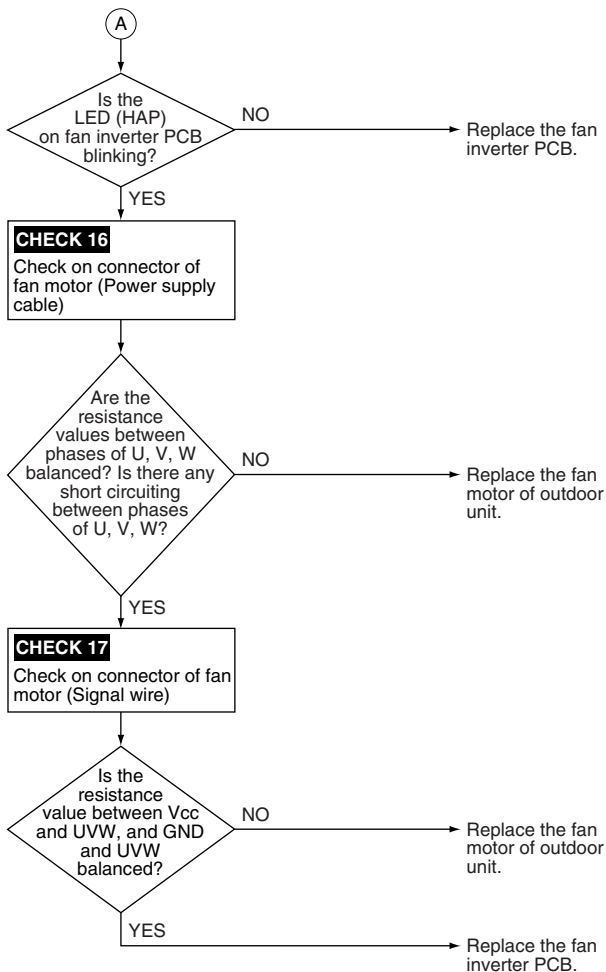

**CHECK 16** Refer to P.378.

## 3.29 E9 Electronic Expansion Valve Coil Abnormality

### Remote Controller Display

E9

### Applicable Models

VRVIII, III-S and III-Q Series

### Method of Error Detection

Check disconnection of connector

To be detected based on continuity existence of electronic expansion valve coil

### Error Decision Conditions

No current is detected in the common (COM [+]) when power supply is ON.

### Supposed Causes

- Disconnection of connectors for electronic expansion valve
- Defective electronic expansion valve coil
- Defective outdoor unit main PCB

## Troubleshooting



### Caution

Be sure to turn off the power switch before connecting or disconnecting connectors, or parts may be damaged.

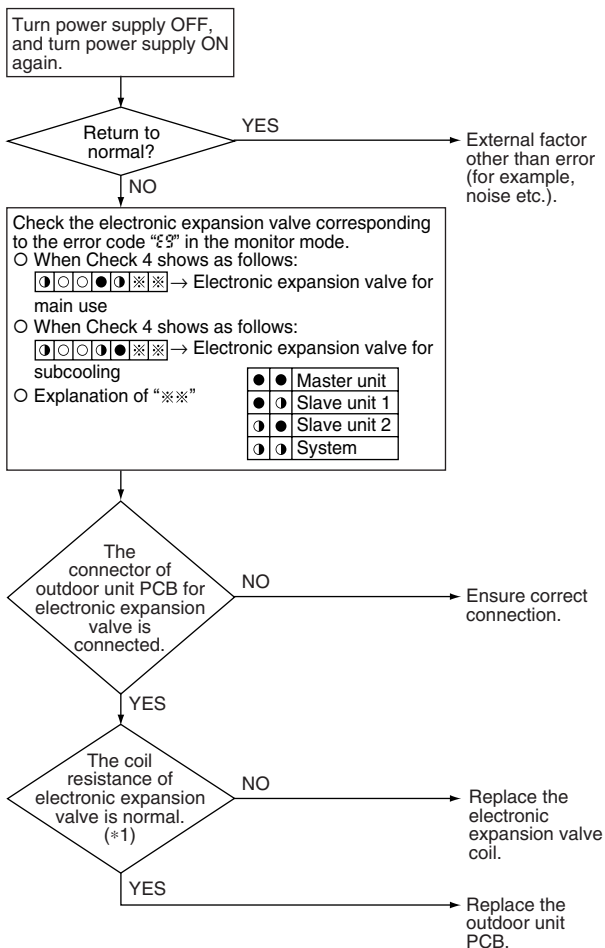





**Note:**

- \*1. Make measurement of resistance between the connector pins, and then make sure the resistance falls in the range of 40 to 50Ω.

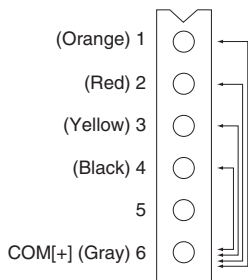

Measuring points	Judgement criteria
1 - 6	40~50Ω
2 - 6	
3 - 6	
4 - 6	

## Remote Controller Display

**E9**

### Applicable Models

VRVII, -WII, -WIII and II-S Series

### Method of Error Detection

Check disconnection of connector

Check continuity of electronic expansion valve coil

### Error Decision Conditions

Error is generated under no common power supply when the power is ON.

### Supposed Causes

- Defective electronic expansion valve coil
- Defective outside unit PCB
- Defective connecting cable

## Troubleshooting



### Caution

Be sure to turn off the power switch before connecting or disconnecting connectors, or parts may be damaged.

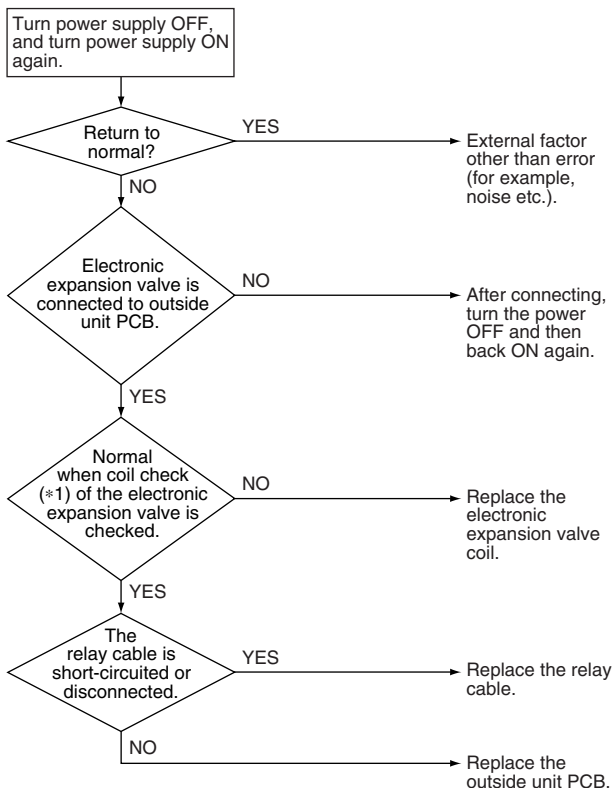

### Note:

- \*1. Coil check method for the electronic expansion valve coil  
Discount the electronic expansion valve from the PCB and check the continuity between the connector nine

## (Normal)

Pin No.	1. White	2. Yellow	3. Orange	4. Blue	5. Red	6. Brown
1. White		x	○ Approx. 300Ω	x	○ Approx. 150Ω	x
2. Yellow			x	○ Approx. 300Ω	x	○ Approx. 150Ω
3. Orange				x	○ Approx. 150Ω	x
4. Blue					x	○ Approx. 150Ω
5. Red						x
6. Brown						

○: Continuity

x: No continuity

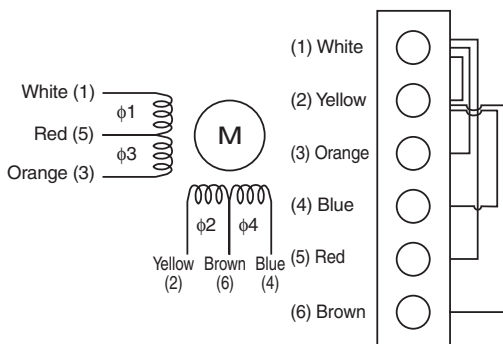

## 3.30 F3 Abnormal Discharge Pipe Temperature

### Remote Controller Display

F3

### Applicable Models

VRVIII, III-S and III-Q Series

### Method of Error Detection

Abnormality is detected according to the temperature detected by the discharge pipe thermistor.

### Error Decision Conditions

When the discharge pipe temperature rises to an abnormally high level

When the discharge pipe temperature rises suddenly

### Supposed Causes

- Defective discharge pipe thermistor
- Defective connection of discharge pipe thermistor
- Defective outdoor unit PCB

## Troubleshooting



### Caution

Be sure to turn off the power switch before connecting or disconnecting connectors, or parts may be damaged.

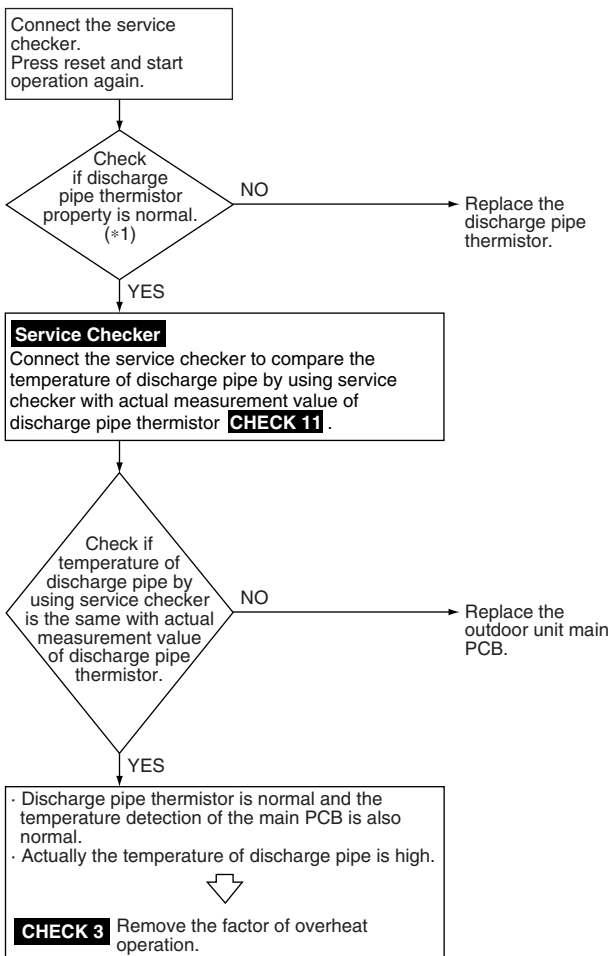



**Note:**

- \*1. Compare the resistance value of discharge pipe thermistor and the value based on the surface thermometer.



**CHECK 3** Refer to P.351.



**CHECK 11** Refer to P.369.

## Remote Controller Display

F3

### Applicable Models

VRV-WII and -WIII Series

### Method of Error Detection

Abnormality is detected according to the temperature detected by the discharge pipe thermistor.

### Error Decision Conditions

- When the discharge pipe temperature rises to an abnormally high level
- When the discharge pipe temperature rises suddenly

### Supposed Causes

- Defective discharge pipe thermistor
- Defective connection of discharge pipe thermistor
- Defective outside unit PCB



## Troubleshooting



### Caution

Be sure to turn off the power switch before connecting or disconnecting connectors, or parts may be damaged.

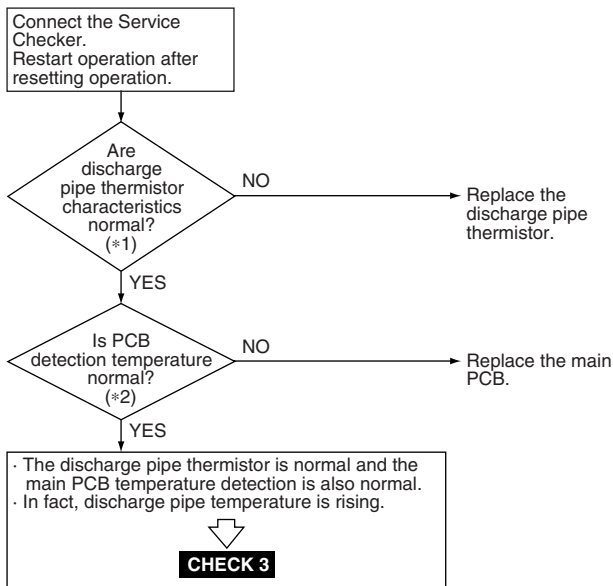

### Note:

- \*1. Compare the resistance values of the discharge pipe thermistor with measurements of a surface thermometer.  
(For temperature and resistance characteristics of a thermistor, refer to P.371.)
- \*2. Compare the discharge pipe temperature checked by the Service Checker with the resistance of the thermistor (refer to \*1).



**CHECK 3** Refer to P.351.

## Remote Controller Display

F3

### Applicable Models

VRVII and II-S Series

### Method of Error Detection

Abnormality is detected according to the temperature detected by the discharge pipe thermistor.

### Error Decision Conditions

When the discharge pipe temperature rises to an abnormally high level

When the discharge pipe temperature rises suddenly

### Supposed Causes

- Defective discharge pipe thermistor
- Defective connection of discharge pipe thermistor
- Defective outdoor unit PCB

## Troubleshooting



### Caution

Be sure to turn off the power switch before connecting or disconnecting connectors, or parts may be damaged.

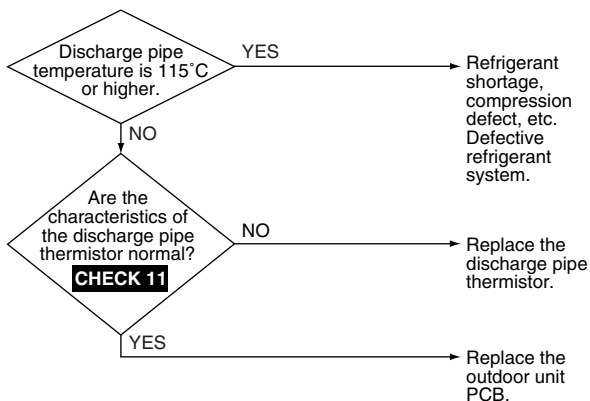

**CHECK 11** Refer to P.369.

## 3.31 F6 Refrigerant Overcharged

### Remote Controller Display

F6

### Applicable Models

VRVIII, III-S and III-Q Series

### Method of Error Detection

Excessive charging of refrigerant is detected by using the outdoor air temperature, heat exchanger deicer temperature and liquid pipe temperature during check operation.

### Error Decision Conditions

When the amount of refrigerant, which is calculated by using the outdoor air temperature, heat exchanging deicer temperature and liquid pipe temperature during check operation, exceeds the criteria.

### Supposed Causes

- Refrigerant overcharge
- Disconnection of outdoor air thermistor
- Disconnection of heat exchanger deicer thermistor
- Defective liquid pipe thermistor

## Troubleshooting



### Caution

Be sure to turn off the power switch before connecting or disconnecting connectors, or parts may be damaged.

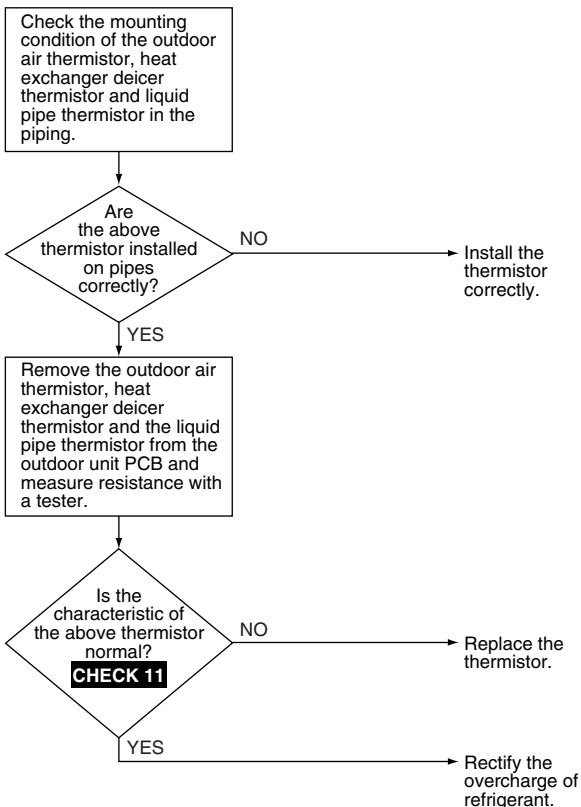

**CHECK 11** Refer to P.369.

## Remote Controller Display

**F6**

### Applicable Models

VRV-WII and -WIII Series

### Method of Error Detection

Detect excessive charging of refrigerant using suction pipe temperature and subcooling heat exchanger outlet temperature during check operation.

### Error Decision Conditions

When the suction pipe temperature and the subcooling heat exchanger outlet temperature during check operation drop and become below the evaporation temperature

### Supposed Causes

- Excessive refrigerant charging
- Suction pipe thermistor removed
- Subcooling heat exchanger outlet thermistor removed

## Troubleshooting



### Caution

Be sure to turn off the power switch before connecting or disconnecting connectors, or parts may be damaged.

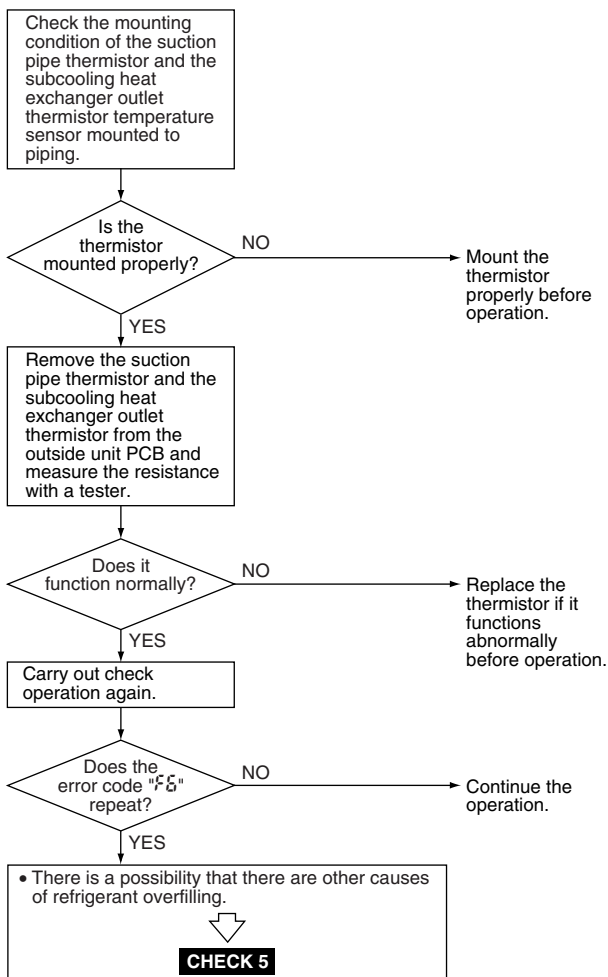

## Remote Controller Display

FE

## Applicable Models

VRVII Series

## Method of Error Detection

Refrigerant overcharge is detected from suction pipe and subcooling heat exchanger gas pipe temperature during check operation.

## Error Decision Conditions

When the suction pipe and subcooling heat exchanger gas pipe temperature is lower than evaporating temperature during check operation.

## Supposed Causes

- Refrigerant overcharge
- Disconnection of the receiver gas pipe thermistor

## Troubleshooting



**Caution**

Be sure to turn off the power switch before connecting or disconnecting connectors, or parts may be damaged.

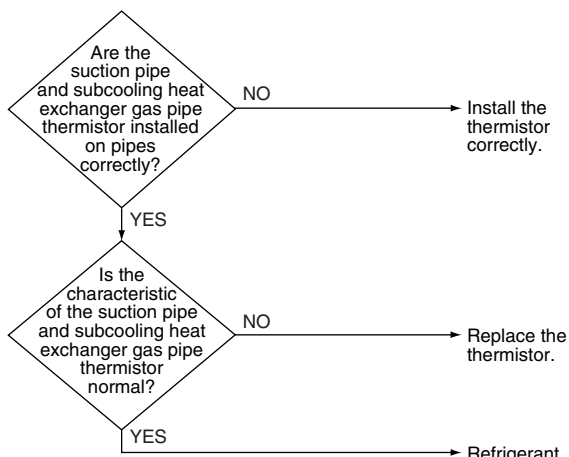



## 3.32 H3 High Pressure Switch System Abnormality

### Remote Controller Display

H3

### Applicable Models

VRVIII-Q

### Method of Error Detection

The protection device circuit checks continuity in the high pressure switch.

### Error Decision Conditions

When there is no continuity in the high pressure switch during the compressor stops operating.

### Supposed Causes

- Defective high pressure switch
- Broken of high pressure switch harness
- Defective connection of high pressure switch connector
- Defective compressor
- Defective outdoor unit PCB
- Broken of lead wire

## Troubleshooting



### Caution

Be sure to turn off the power switch before connecting or disconnecting connectors, or parts may be damaged.

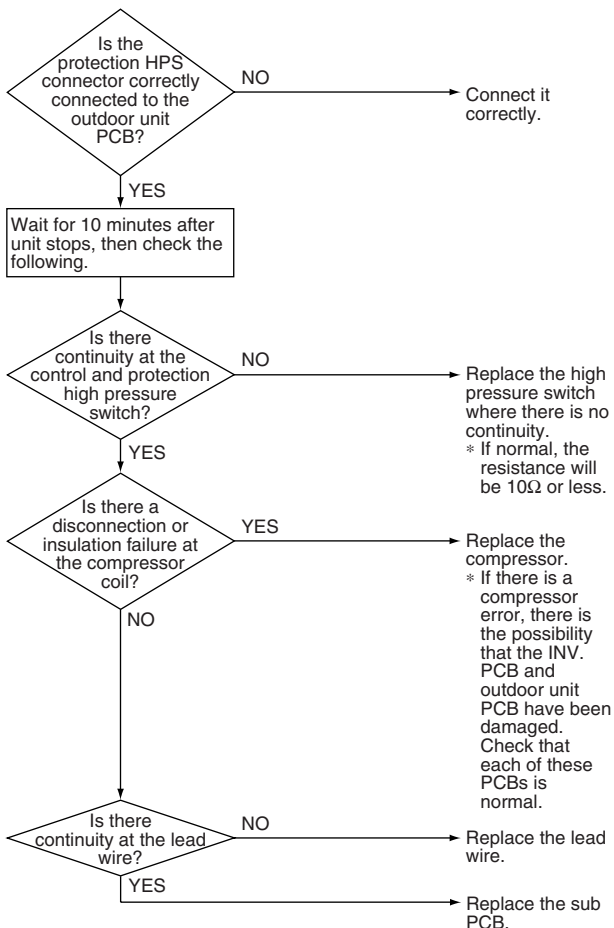

## 3.33 H7 Outdoor Unit Fan Motor Signal Abnormality

### Remote Controller Display

H7

### Applicable Models

VRVIII and III-Q Series

### Method of Error Detection

Detection of abnormal signal from fan motor.

### Error Decision Conditions

In case of detection of abnormal signal at starting fan motor.

### Supposed Causes

- Defective fan motor signal (circuit error)
- Broken, short circuited or disconnection connector of fan motor connection cable
- Defective fan Inverter PCB

## Troubleshooting



### Caution

Be sure to turn off the power switch before connecting or disconnecting connectors, or parts may be damaged.

Check the fan motor corresponding to the error code “H” in the monitor mode.

When check 3 shows as follows:

●●●●●●●● → Fan motor 1 (M1F)

When check 3 shows as follows:

●●●●●●●● → Fan motor 2 (M2F)

Identify outdoor unit based on Check 4.

●●●●●●●●

Explanation for “●●●●”

●●	Master unit
●●	Slave unit 1
●●	Slave unit 2
●●	System

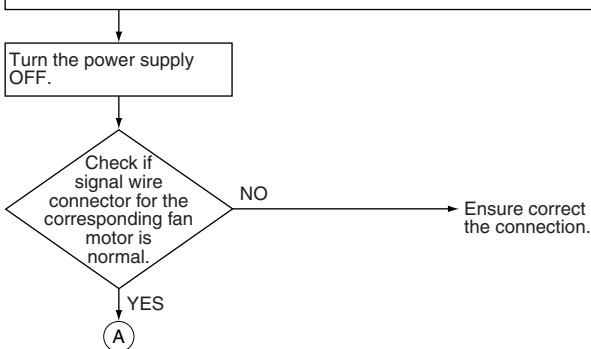

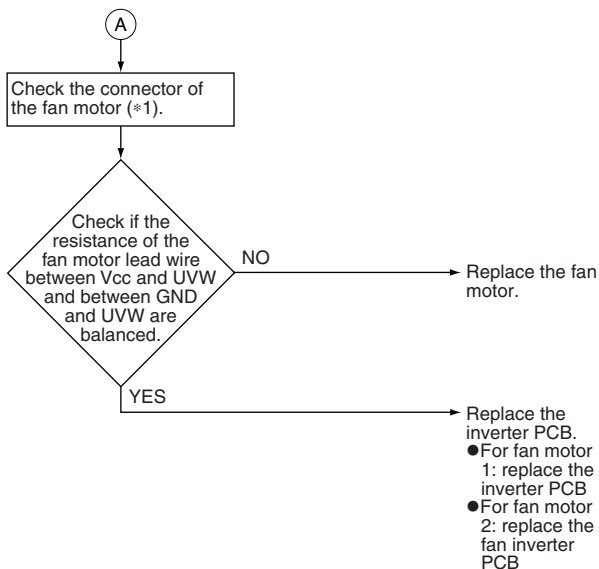

**Note:**

\*1. Check procedure for fan motor connector

- (1) Power OFF the fan motor.
- (2) Remove the connector on the PCB to measure the following resistance value.

Judgement criteria: resistance value between each phase is within  $\pm 20\%$

Connector for signal wires.

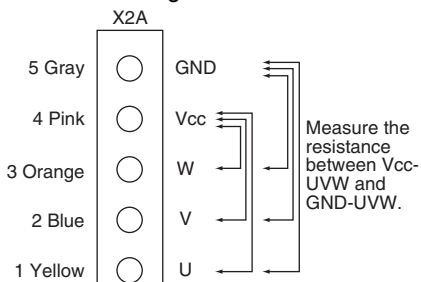

## Remote Controller Display



## Applicable Models

VRVII Series

## Method of Error Detection

Detection of abnormal signal from fan motor.

## Error Decision Conditions

In case of detection of abnormal signal at starting fan motor.

## Supposed Causes

- Abnormal fan motor signal (circuit error)
- Broken, short or disconnection connector of fan motor connection cable
- Defective fan Inverter PCB

## Troubleshooting



### Caution

Be sure to turn off the power switch before connecting or disconnecting connectors, or parts may be damaged.

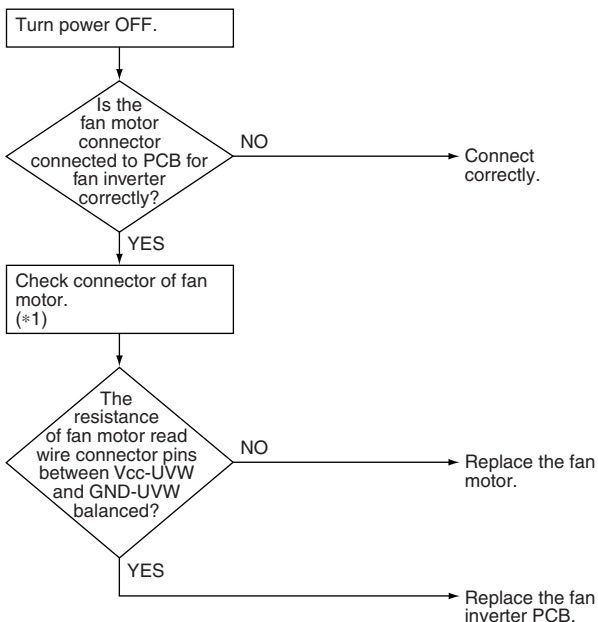

\*1: Disconnect connector and measure the following resistance.

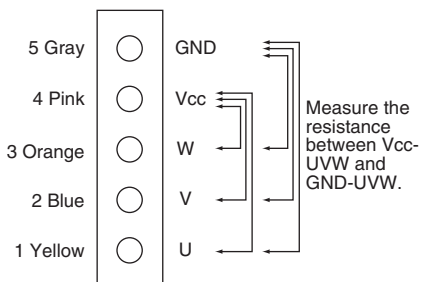

## 3.34 **H9** Outdoor Air Thermistor Abnormality

### Remote Controller Display

**H9**

### Applicable Models

VRVIII, III-S and III-Q Series

### Method of Error Detection

Error is detected from the temperature detected by the outdoor air thermistor.

### Error Decision Conditions

When the outdoor air thermistor has short circuit or open circuit.

### Supposed Causes

- Defective thermistor connection
- Defective thermistor for outdoor air
- Defective outdoor unit PCB



## Troubleshooting



### Caution

Be sure to turn off the power switch before connecting or disconnecting connectors, or parts may be damaged.

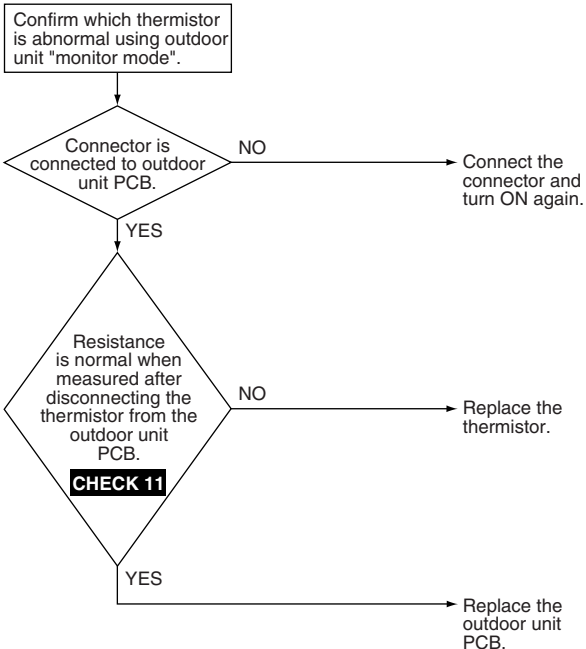

**CHECK 11** Refer to P.369.

## Remote Controller Display

H9

### Applicable Models

VRVII and II-S Series

### Method of Error Detection

The abnormal detection is based on current detected by current sensor.

### Error Decision Conditions

When the outdoor air temperature sensor has short circuit or open circuit.

### Supposed Causes

- Defective outdoor air thermistor
- Defective outdoor unit PCB

## Troubleshooting



### Caution

Be sure to turn off the power switch before connecting or disconnecting connectors, or parts may be damaged.

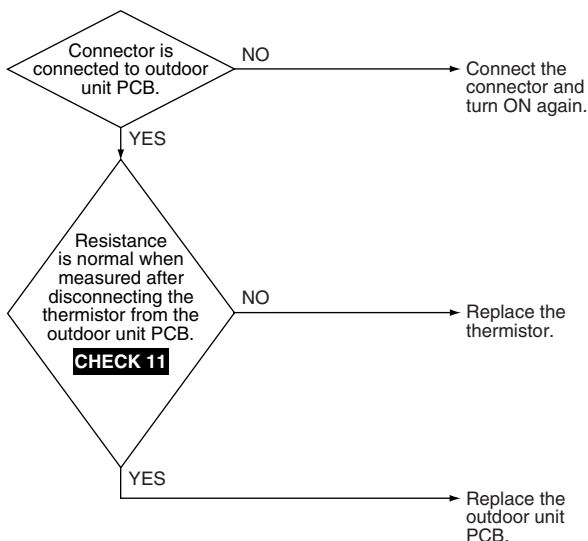

The alarm indicator is displayed when the fan only is being used also.



**CHECK 11** Refer to P.369.

## 3.35 HU Water System Error

### Remote Controller Display

HU

### Applicable Models

VRV-WII and -WIII Series

### Method of Error Detection

- Detect abnormalities using the thermistor on the side of the heat exchanger gas.
- Detect turned OFF interlock circuit.  
(When interlock setting is provided.)

### Error Decision Conditions

- When temperature on the heat exchanger gas side drops remarkably with the smallest operation step of the compressor
- With interlock setting provided, when interlock circuit is turned OFF.

### Supposed Causes

- Clogged water piping system
- Insufficient heat exchanger water
- Dirty heat exchanger
- Disconnected connector
- Defective thermistor on the heat exchanger gas side
- Defective low pressure sensor

## Troubleshooting



### Caution

Be sure to turn off the power switch before connecting or disconnecting connectors, or parts may be damaged.

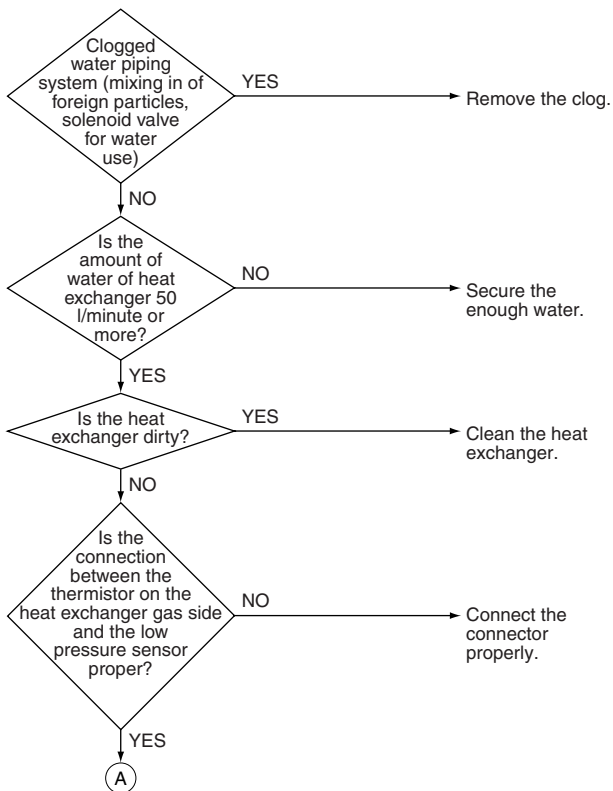

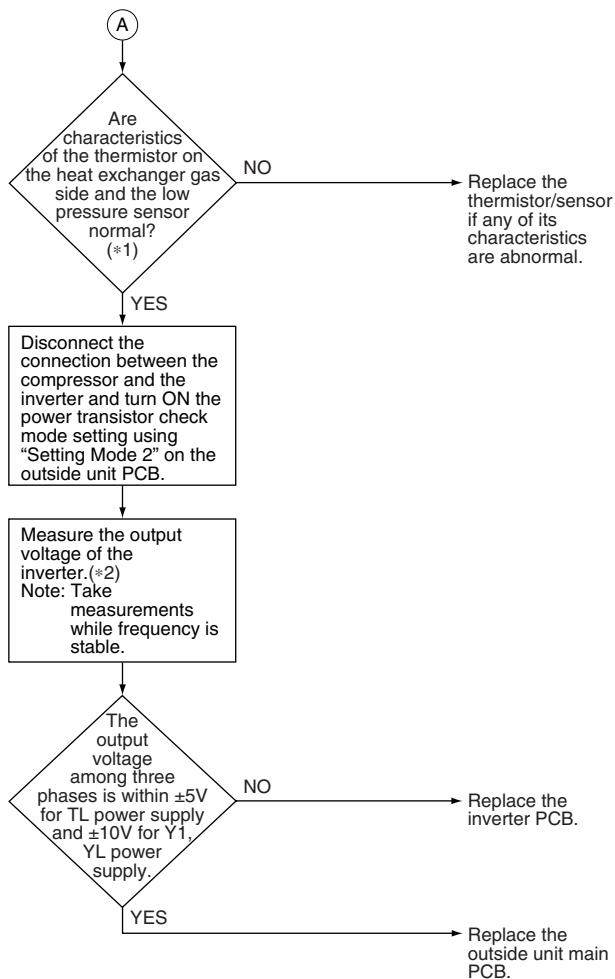

\*1: For thermistor/sensor characteristics, refer to P.369.

\*2: The quality of the power transistor diode module can be assessed by means of measurement of resistance between terminals (Refer to P.354).

## 3.36 High Pressure Sensor Abnormality

### Remote Controller Display



### Applicable Models

VRVIII-Q Series

### Method of Error Detection

Error is detected from the pressure measured with high pressure sensor.

### Error Decision Conditions

When the high pressure sensor is short-circuit or open circuit.

### Supposed Causes

- Defective high pressure sensor
- Connection of low pressure sensor with wrong connection.
- Defective outdoor unit PCB.
- Defective connection of high pressure sensor

## Troubleshooting



### Caution

Be sure to turn off the power switch before connecting or disconnecting connectors, or parts may be damaged.

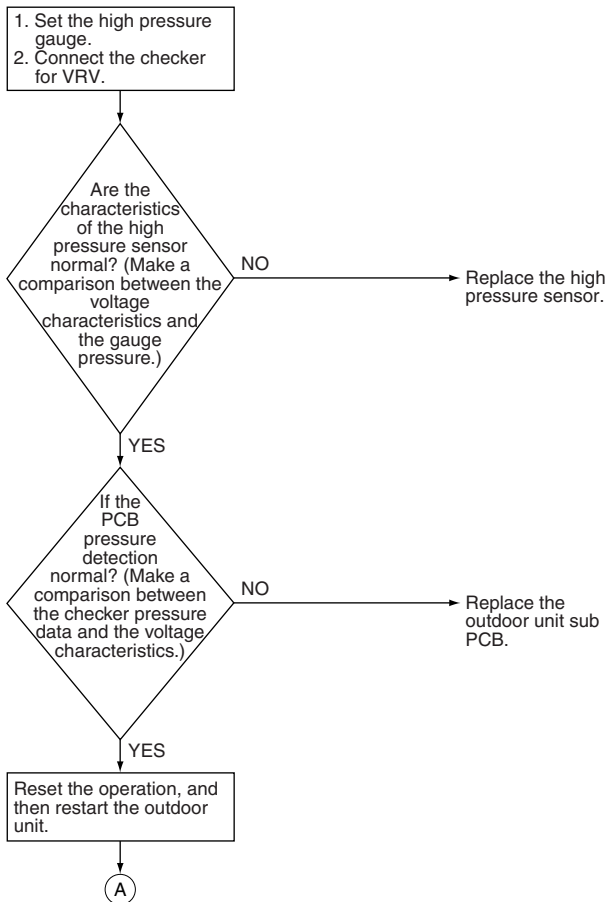



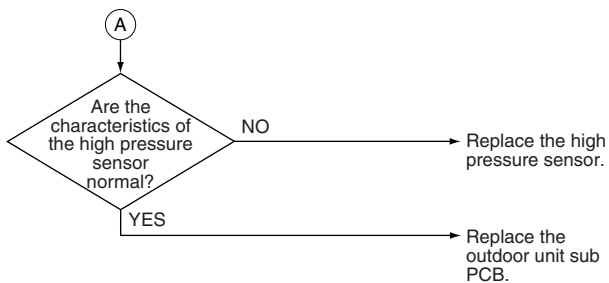

## 3.37 Current Sensor Abnormality

### Remote Controller Display



### Applicable Models

VRVIII and III-Q Series

### Method of Error Detection

Error is detected according to the current value detected by current sensor.

### Error Decision Conditions

When the current value detected by current sensor becomes 5A or lower, or 40A or more during standard compressor operation.

### Supposed Causes

- Defective current sensor
- Defective outdoor unit PCB
- Defective compressor

## Troubleshooting



### Caution

Be sure to turn off the power switch before connecting or disconnecting connectors, or parts may be damaged.

Check the current sensor corresponding to the error code “J2” in the monitor mode.

○ Check 4 shows as follows:

●○○○●●※※ → Current sensor for constant rate compressor 1

○ Check 4 shows as follows:

●○○○●○※※ → Current sensor for constant rate compressor 2

○ Explanation for “※※”

●	●	Master unit
●	○	Slave unit 1
○	●	Slave unit 2
○	○	System

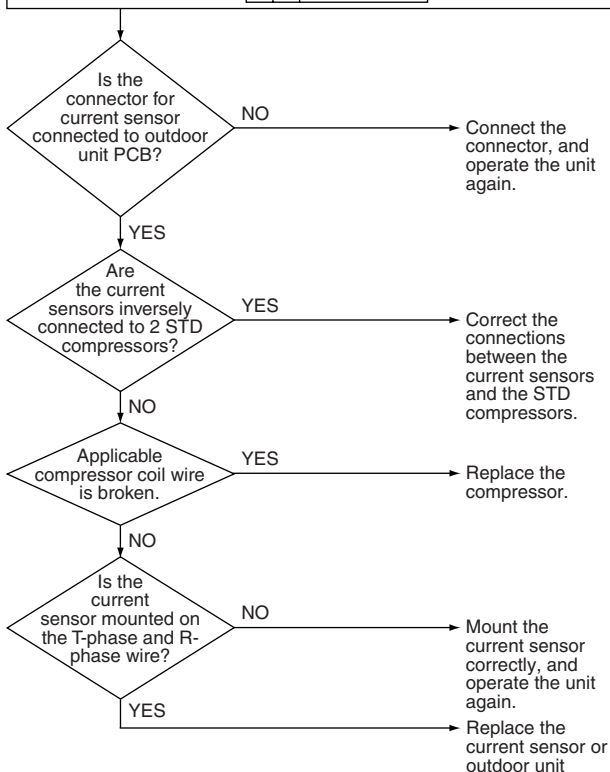

## Remote Controller Display



## Applicable Models

VRVII Series

## Method of Error Detection

Error is detected according to the current value detected by current sensor.

## Error Decision Conditions

When the current value detected by current sensor becomes 5A or lower, or 40A or more during standard compressor operation.

## Supposed Causes

- Defective current sensor
- Defective outdoor unit PCB

## Troubleshooting



**Caution**

Be sure to turn off the power switch before connecting or disconnecting connectors, or parts may be damaged.

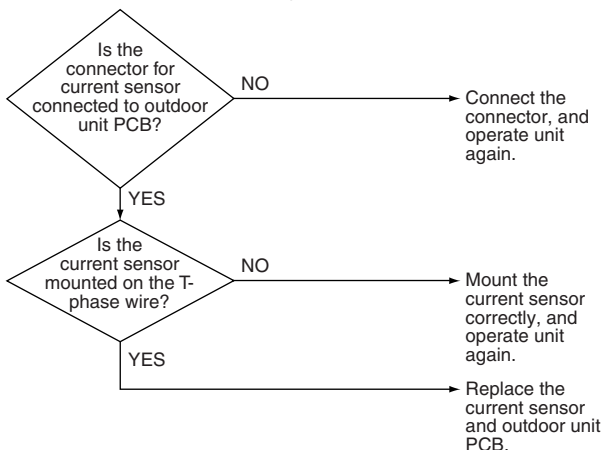

## 3.38 Discharge Pipe Thermistor Abnormality

### Remote Controller Display



### Applicable Models

All outdoor unit series

### Method of Error Detection

Error is detected from the temperature detected by discharge pipe thermistor.

### Error Decision Conditions

When a short circuit or an open circuit in the discharge pipe thermistor is detected.

### Supposed Causes

- Defective thermistor for outdoor unit discharge pipe
- Defective outdoor unit PCB
- Defective thermistor connection

## Troubleshooting



### Caution

Be sure to turn off the power switch before connecting or disconnecting connectors, or parts may be damaged.

Confirm which discharge pipe thermistor is abnormal using outdoor unit "monitor mode".

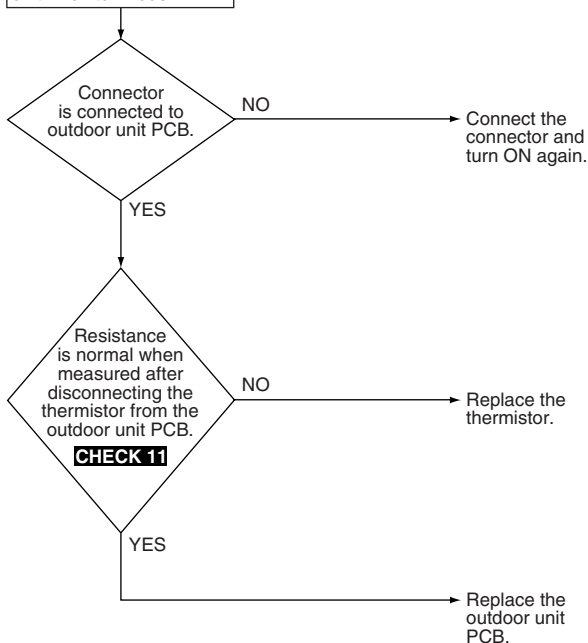

The alarm indicator is displayed when the fan is being used also.



**CHECK 11** Refer to P.369.

## 3.39 Heat Exchanger Gas Pipe Thermistor Abnormality

### Remote Controller Display



### Applicable Models

VRV-WII and -WIII Series

### Method of Error Detection

Error is detected according to the temperature detected by heat exchanger gas pipe thermistor.

### Error Decision Conditions

When the heat exchanger gas pipe thermistor is short circuited or open.

### Supposed Causes

- Defective heat exchanger gas pipe thermistor
- Defective outside unit PCB

## Troubleshooting



### Caution

Be sure to turn off the power switch before connecting or disconnecting connectors, or parts may be damaged.

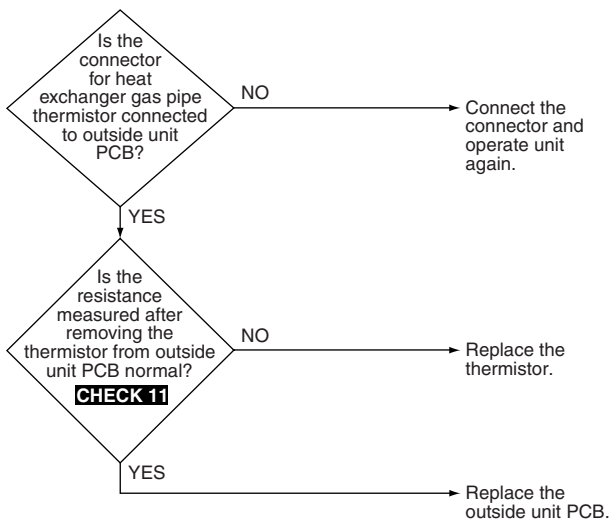

**CHECK 11** Refer to P.369.



## 3.40 U5 Suction Pipe Thermistor Abnormality

### Remote Controller Display



### Applicable Models

All outdoor unit models

### Method of Error Detection

Error is detected from the temperature detected by the suction pipe thermistor.

### Error Decision Conditions

When a short circuit or an open circuit in the suction pipe thermistor is detected.

### Supposed Causes

- Defective thermistor for outdoor unit suction pipe
- Defective outdoor unit PCB
- Defective thermistor connection

## Troubleshooting



### Caution

Be sure to turn off the power switch before connecting or disconnecting connectors, or parts may be damaged.

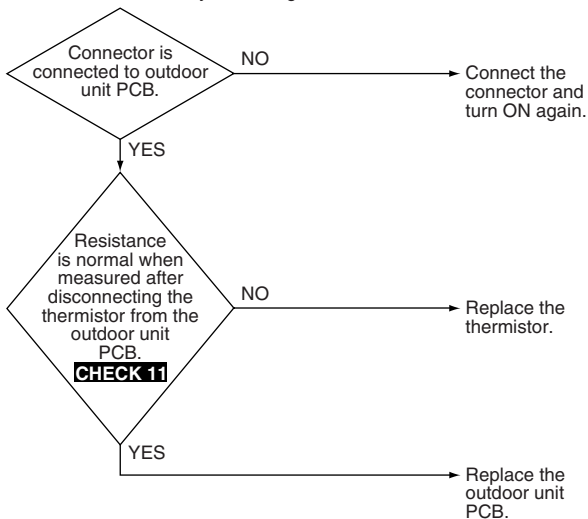

**CHECK 11** Refer to P.369.

## 3.41 Outdoor Unit Heat Exchanger Thermistor Abnormality

### Remote Controller Display



### Applicable Models

VRVII, II-S, III, III-S and III-Q Series

### Method of Error Detection

Error is detected from the temperature detected by the outdoor unit heat exchanger thermistor.

### Error Decision Conditions

When a short circuit or an open circuit in the heat exchanger thermistor is detected.

### Supposed Causes

- Defective thermistor for outdoor unit coil
- Defective outdoor unit PCB
- Defective thermistor connection

## Troubleshooting



### Caution

Be sure to turn off the power switch before connecting or disconnecting connectors, or parts may be damaged.

Confirm which thermistor is abnormal using outdoor unit "monitor mode".

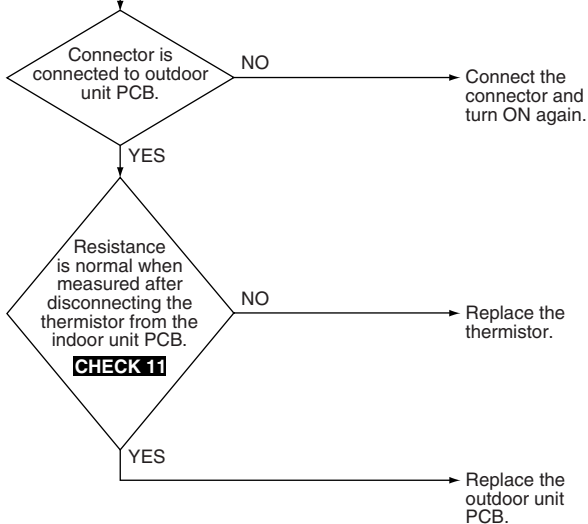

**CHECK 11** Refer to P.369.

## 3.42 Liquid Pipe Thermistor Abnormality

### Remote Controller Display



### Applicable Models

VRVII, -WII, III, -WIII, III-S and III-Q Series

### Method of Error Detection

Error is detected according to the temperature detected by liquid pipe thermistor.

### Error Decision Conditions

When the liquid pipe thermistor is short circuited or open circuited.

### Supposed Causes

- Defective liquid pipe thermistor
- Defective outdoor (outside) unit PCB
- Defective thermistor connection

## Troubleshooting



### Caution

Be sure to turn off the power switch before connecting or disconnecting connectors, or parts may be damaged.

Confirm which thermistor is abnormal using outdoor unit "monitor mode".

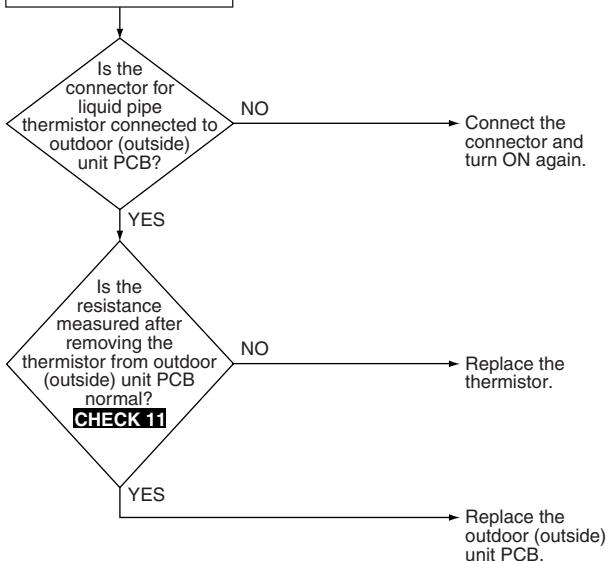

### CHECK 11

Refer to P.369.

## 3.43 Thermistor System Abnormality

### Remote Controller Display



### Applicable Models

VRVIII-Q Series

### Method of Error Detection

Error is detected according to the temperature detected by each individual thermistor.

### Error Decision Conditions

When thermistor is disconnected or short-circuited during operation

### Supposed Causes

- Defective thermistor
- Defective connection of connector
- Defective outdoor unit PCB (control PCB)

## Troubleshooting



### Caution

Be sure to turn off the power switch before connecting or disconnecting connectors, or parts may be damaged.

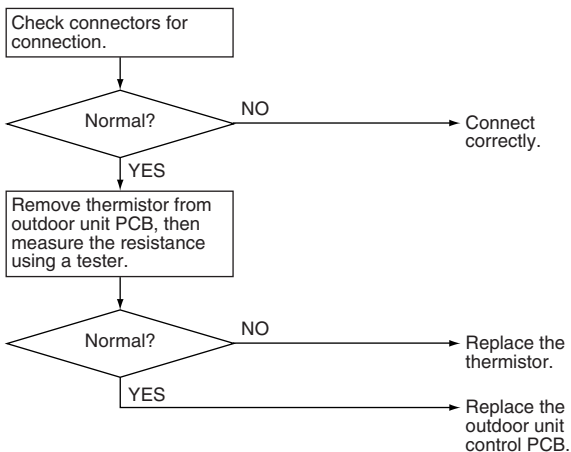



## 3.44 Subcooling Heat Exchanger Gas Pipe Thermistor Abnormality

### Remote Controller Display



### Applicable Models

All outdoor unit series

### Method of Error Detection

Error is detected according to the temperature detected by subcooling heat exchanger gas pipe thermistor.

### Error Decision Conditions

When the subcooling heat exchanger gas pipe thermistor is short circuited or open circuited.

### Supposed Causes

- Defective subcooling heat exchanger gas pipe thermistor
- Defective outdoor unit PCB

## Troubleshooting



### Caution

Be sure to turn off the power switch before connecting or disconnecting connectors, or parts may be damaged.

Confirm which thermistor is abnormal using outdoor unit "monitor mode".

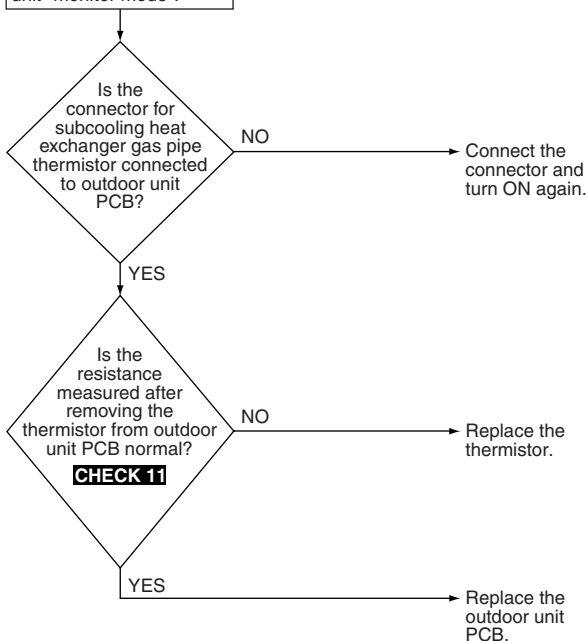

**CHECK 11** Refer to P.369.

## 3.45 High Pressure Sensor Abnormality

### Remote Controller Display



### Applicable Models

VRVIII, III-S and III-Q Series

### Method of Error Detection

Error is detected from the pressure detected by the high pressure sensor.

### Error Decision Conditions

When the high pressure sensor is short circuit or open circuit.

### Supposed Causes

- Defective high pressure sensor system
- Connection of low pressure sensor with wrong connection.
- Defective outdoor unit PCB.
- Defective connection of high pressure sensor

## Troubleshooting



### Caution

Be sure to turn off the power switch before connecting or disconnecting connectors, or parts may be damaged.

Confirm which high pressure sensor is abnormal using outdoor unit "monitor mode".

1. Set the high pressure gauge upright.
2. Connect the checker for VRV to the gauge.

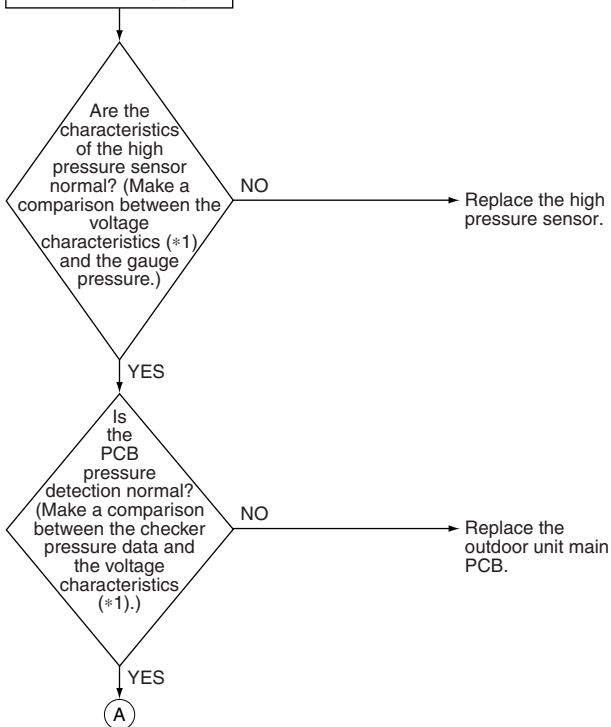

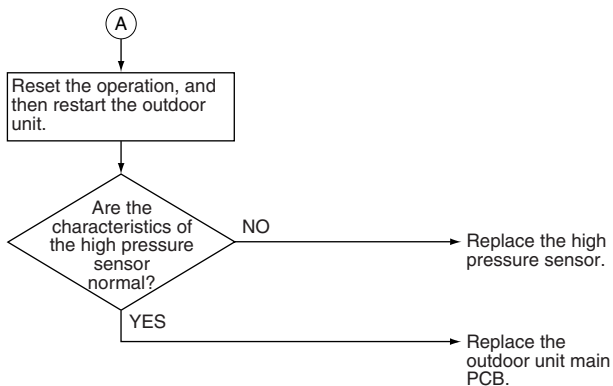

**i** Note:

\*1. Voltage measurement point

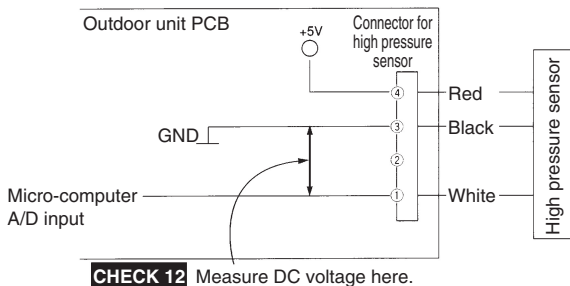

**↩** **CHECK 12** Refer to P.372.

## 3.46 Discharge Pipe Pressure Sensor Abnormality

### Remote Controller Display



### Applicable Models

VRVII, II-S, -WII and -WIII Series

### Method of Error Detection

Error is detected from the pressure detected by the high pressure sensor.

### Error Decision Conditions

When the discharge pipe pressure sensor is short circuit or open circuit.

### Supposed Causes

- Defective high pressure sensor system
- Connection of low pressure sensor with wrong connection.
- Defective outdoor (outside) unit PCB.

## Troubleshooting



### Caution

Be sure to turn off the power switch before connecting or disconnecting connectors, or parts may be damaged.

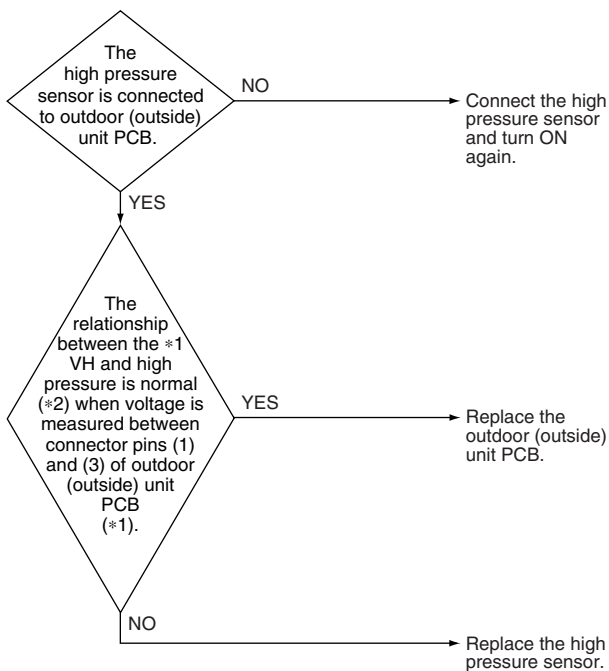

## \*1: Voltage measurement point

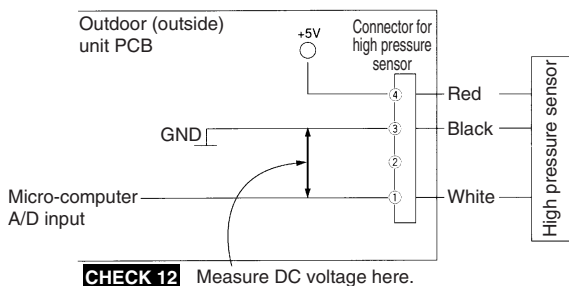

**CHECK 12** Refer to P.372.



## 3.47 Low Pressure Sensor Abnormality

### Remote Controller Display



### Applicable Models

VRVIII, III-S and III-Q Series

### Method of Error Detection

Error is detected from pressure detected by the low pressure sensor.

### Error Decision Conditions

When the low pressure sensor is short circuit or open circuit.

### Supposed Causes

- Defective low pressure sensor
- Connection of high pressure sensor with wrong connection
- Defective outdoor unit PCB
- Defective connection of low pressure sensor

## Troubleshooting



### Caution

Be sure to turn off the power switch before connecting or disconnecting connectors, or parts may be damaged.

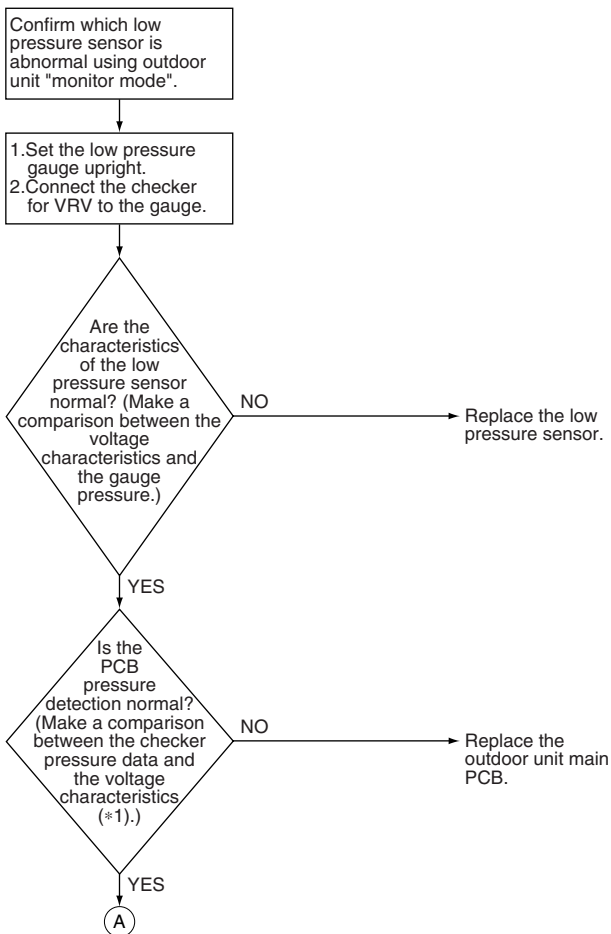

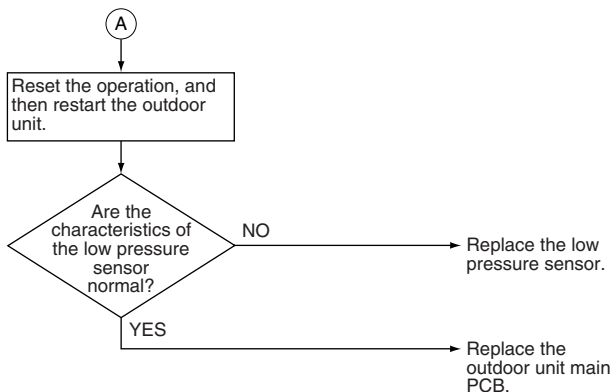

**i** Note:

\*1. Voltage measurement point

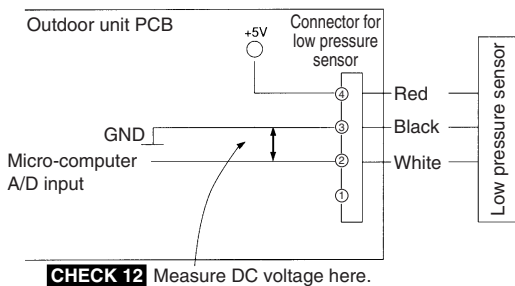

**↩** **CHECK 12** Refer to P.372.

## 3.48 Suction Pipe Pressure Sensor Abnormality

### Remote Controller Display



### Applicable Models

VRVII, II-S, -WII and -WIII Series

### Method of Error Detection

Error is detected from pressure detected by low pressure sensor.

### Error Decision Conditions

When the suction pipe pressure sensor is short circuit or open circuit.

### Supposed Causes

- Defective low pressure sensor system
- Connection of high pressure sensor with wrong connection.
- Defective outdoor (outside) unit PCB.

## Troubleshooting



### Caution

Be sure to turn off the power switch before connecting or disconnecting connectors, or parts may be damaged.

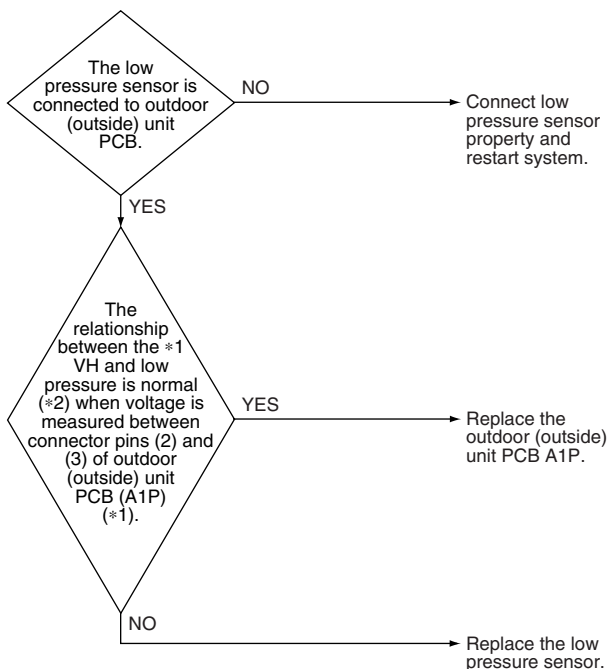

**i** Note:

\*1: Voltage measurement point

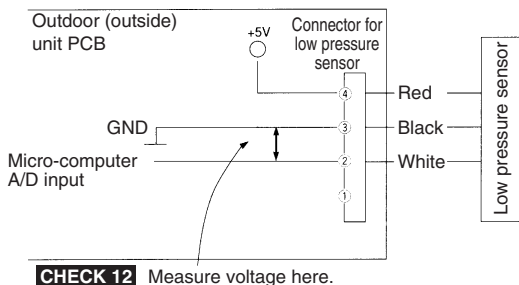

**L** **CHECK 12** Refer to P.372.

## 3.49 Inverter PCB Abnormality

### Remote Controller Display



### Applicable Models

VRVIII Series

### Method of Error Detection

Error is detected based on the current value during waveform output before starting compressor.

Error is detected based on the value from current sensor during synchronous operation when starting the unit.

### Error Decision Conditions

Overcurrent flows during waveform output.

Defective current sensor during synchronous operation.

IPM failure.

### Supposed Causes

- Inverter PCB
  - IPM failure
  - Current sensor failure
  - Drive circuit failure

## Troubleshooting



### Caution

Be sure to turn off the power switch before connecting or disconnecting connectors, or parts may be damaged.

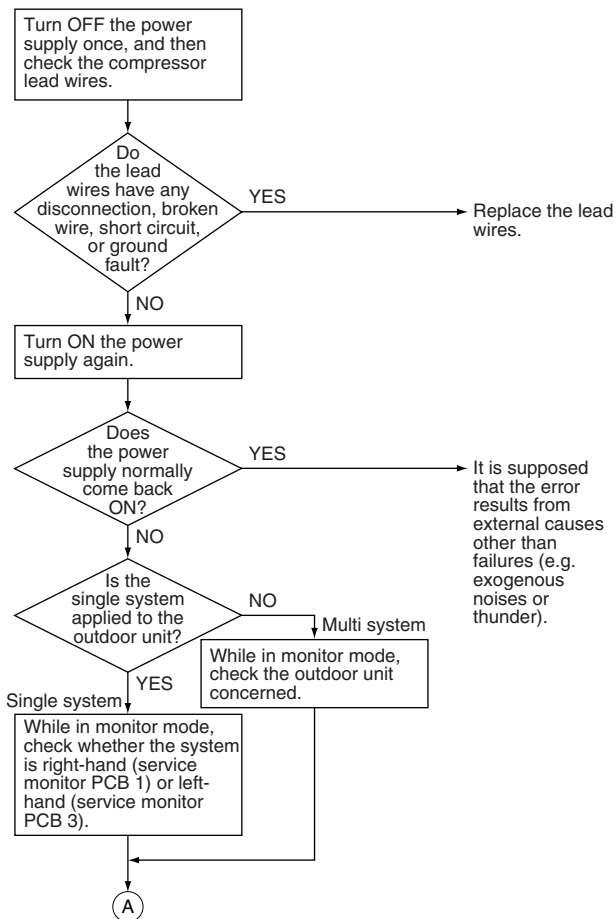



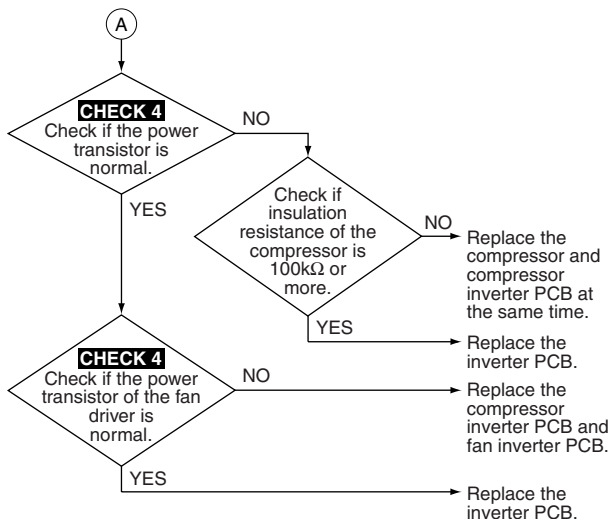

**CHECK 4** Refer to P.354.

## Remote Controller Display



### Applicable Models

VRVIII-S Series

### Method of Error Detection

Error is detected based on the current value during waveform output before starting compressor.

Error is detected based on the value from current sensor during synchronous operation when starting the unit.

### Error Decision Conditions

Overcurrent flows during waveform output.

Error of current sensor during synchronous operation.

IPM failure.

### Supposed Causes

- Main PCB
  - IPM failure
  - Current sensor failure
  - Drive circuit failure

## Troubleshooting



### Caution

Be sure to turn off the power switch before connecting or disconnecting connectors, or parts may be damaged.

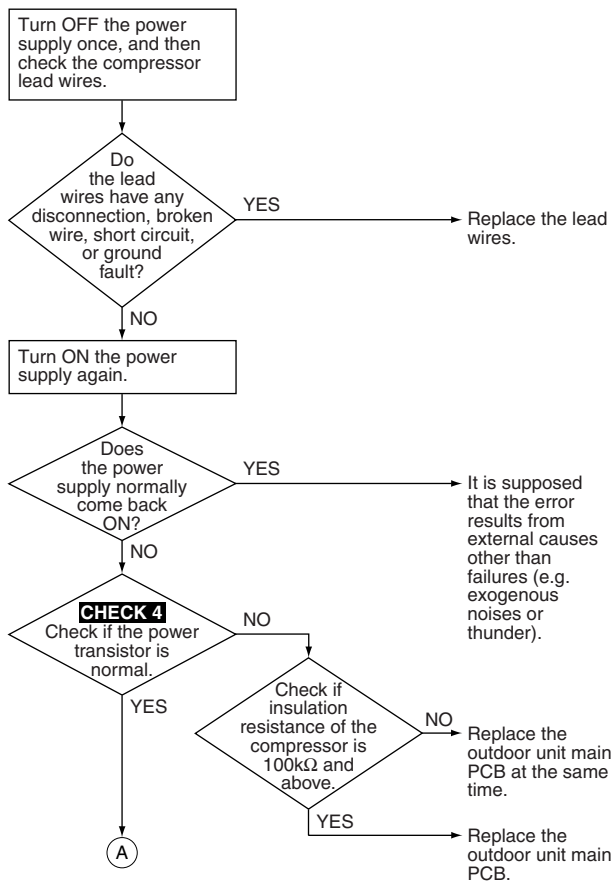

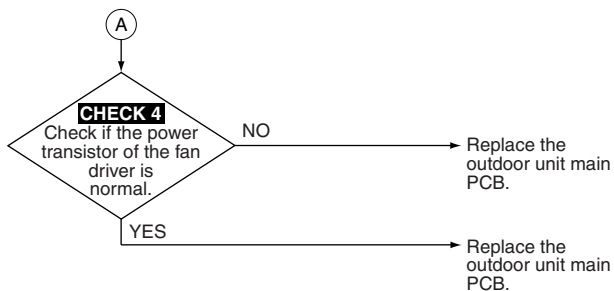

**CHECK 4** Refer to P.354.

## Remote Controller Display



### Applicable Models

VRVIII-Q Series

### Method of Error Detection

- Detect error by current value during waveform output before compressor startup.
- Detect error by current sensor value during synchronized operation at the time of startup.

### Error Decision Conditions

- When overcurrent is detected at the time of waveform output before operating the compressor
- When the current sensor error during synchronized operation
- When overvoltage occurs in IPM

### Supposed Causes

- Defective outdoor unit PCB
  - IPM failure
  - Current sensor failure
  - Defective drive circuit

## Troubleshooting



### Caution

Be sure to turn off the power switch before connecting or disconnecting connectors, or parts may be damaged.

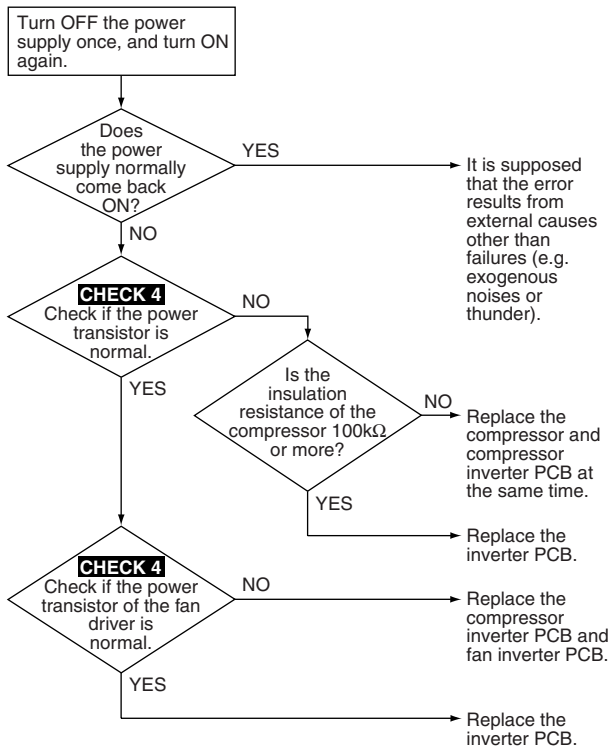

**CHECK 4** Refer to P.354.

## 3.50 L4 Inverter Radiation Fin Temperature Rise Abnormality

### Remote Controller Display

L4

### Applicable Models

VRVIII Series

### Method of Error Detection

Fin temperature is detected by the thermistor of the radiation fin.

### Error Decision Conditions

When the temperature of the inverter radiation fin increases 82°C or more.

### Supposed Causes

- Actuation of radiation fin thermal
- Defective inverter PCB
- Defective radiation fin thermistor

## Troubleshooting



### Caution

Be sure to turn off the power switch before connecting or disconnecting connectors, or parts may be damaged.

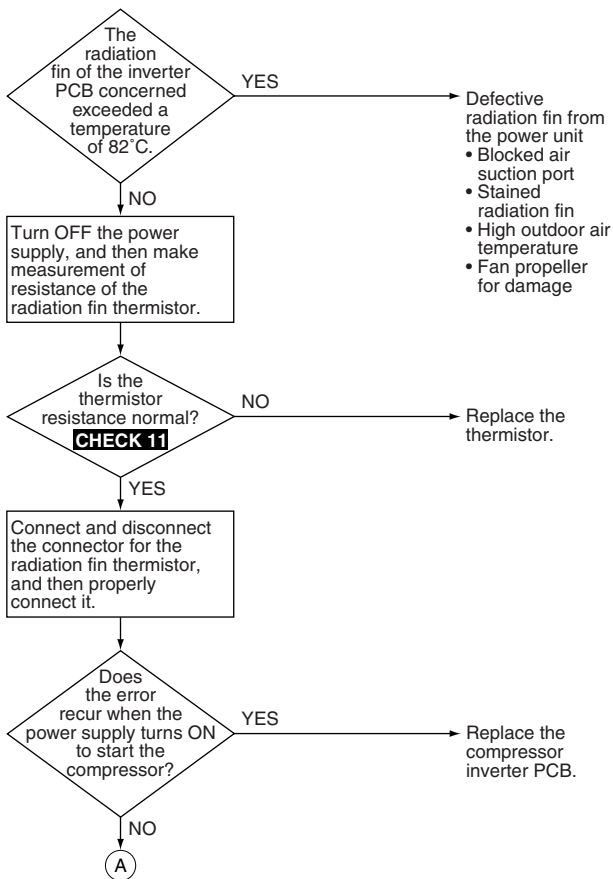



A

Continue operation.

- It is supposed that the radiation fin temperature became high due to some field factors. In this connection, check the following points:
  - Stained radiation fin
  - Airflow obstructed with dirt or foreign matters
  - Damage to fan propeller
  - Too high outdoor air temperature



**CHECK 11** Refer to P.369.

## Remote Controller Display

L4

### Applicable Models

VRVII, -WII, II-S, -WIII, III-S and III-Q Series

### Method of Error Detection

Fin temperature is detected by the thermistor of the radiation fin.

### Error Decision Conditions

When the temperature of the inverter radiation fin increases 96°C or more.

### Supposed Causes

- Actuation of fin thermal
- Defective inverter PCB
- Defective radiation fin thermistor

## Troubleshooting



### Caution

Be sure to turn off the power switch before connecting or disconnecting connectors, or parts may be damaged.

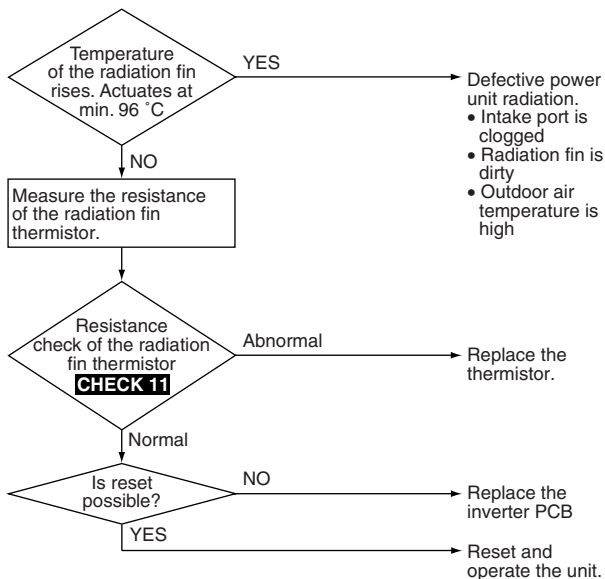

**CHECK 11** Refer to P.369.

## 3.51 U5 Momentary Overcurrent of Inverter Compressor

### Remote Controller Display

U5

### Applicable Models

VRVIII Series

### Method of Error Detection

Error is detected from current flowing in the power transistor.

### Error Decision Conditions

When an excessive current flows in the power transistor. (Instantaneous overcurrent also causes activation.)

### Supposed Causes

- Defective compressor coil (disconnected, defective insulation)
- Compressor startup error (mechanical lock)
- Defective inverter PCB

## Troubleshooting

### Compressor inspection



**Caution**

Be sure to turn off the power switch before connecting or disconnecting connectors, or parts may be damaged.

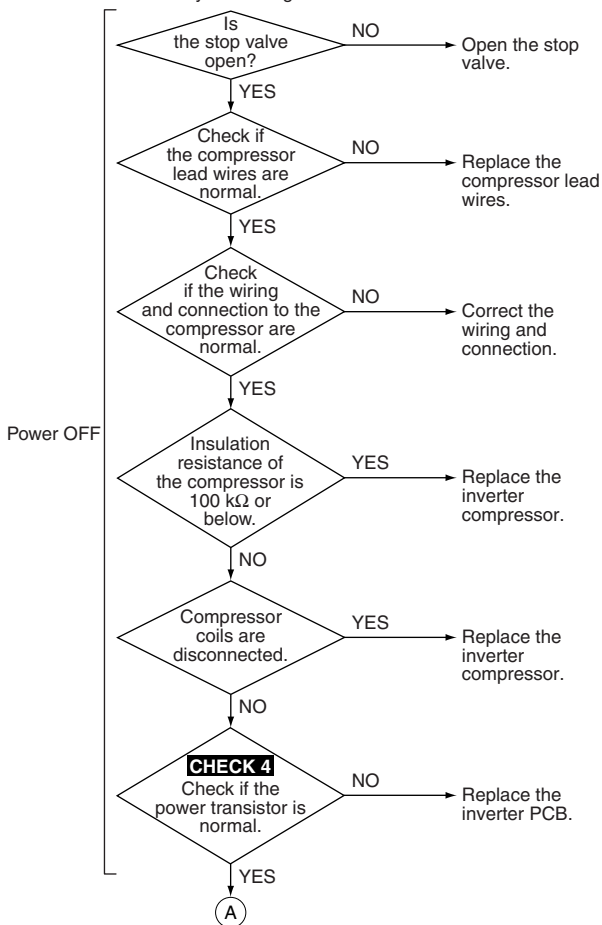

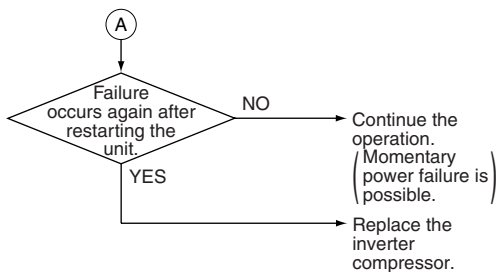

**CHECK 4** Refer to P.354.

## Remote Controller Display

LS

### Applicable Models

VRVII, -WII, II-S, -WIII, III-S and III-Q Series

### Method of Error Detection

Error is detected from current flowing in the power transistor.

### Error Decision Conditions

When an excessive current flows in the power transistor.  
(Instantaneous overcurrent also causes activation.)

### Supposed Causes

- Defective compressor coil (disconnected, defective insulation)
- Compressor startup error (mechanical lock)
- Defective inverter PCB

## Troubleshooting

### Compressor inspection



#### Caution

Be sure to turn off the power switch before connecting or disconnecting connectors, or parts may be damaged.

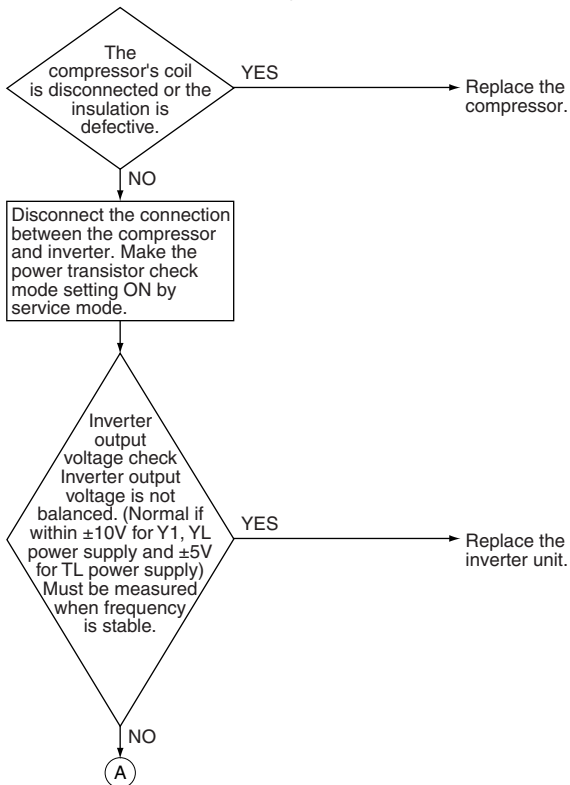



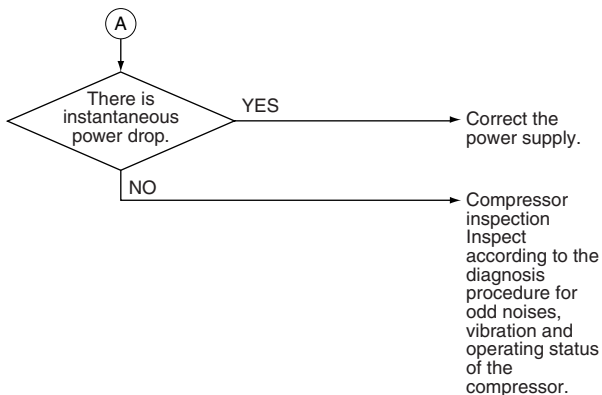

Higher voltage than actual is displayed when the inverter output voltage is checked by tester.

## 3.52 **L8** Momentary Overcurrent of Inverter Compressor

### Remote Controller Display

**L8**

### Applicable Models

VRVIII Series

### Method of Error Detection

Error is detected by current flowing in the power transistor.

### Error Decision Conditions

When overload in the compressor is detected

For 460V units

- (1) 19.0A and over continues for 5 seconds.
- (2) 16.1A and over continues for 260 seconds.

For 230V units

- (1) A current of 33.5A or more continues for a period of consecutive 5 sec.
- (2) A current of 27.6A or more continues for a period of consecutive 260 sec.

### Supposed Causes

- Compressor overload
- Compressor coil disconnected
- Defective inverter PCB
- Disconnection of compressor

## Troubleshooting

### Output current check



**Caution**

Be sure to turn off the power switch before connecting or disconnecting connectors, or parts may be damaged.

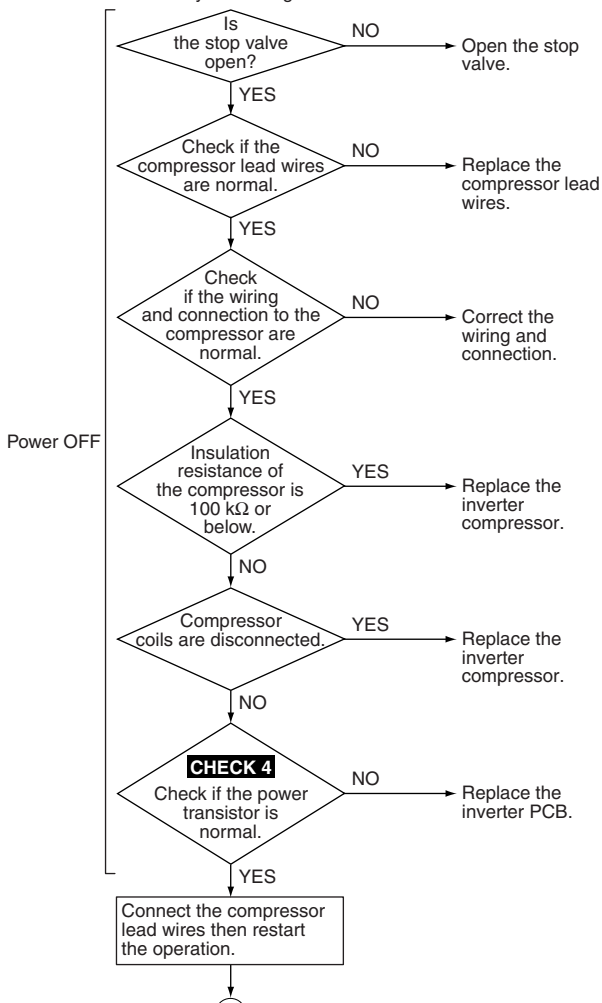

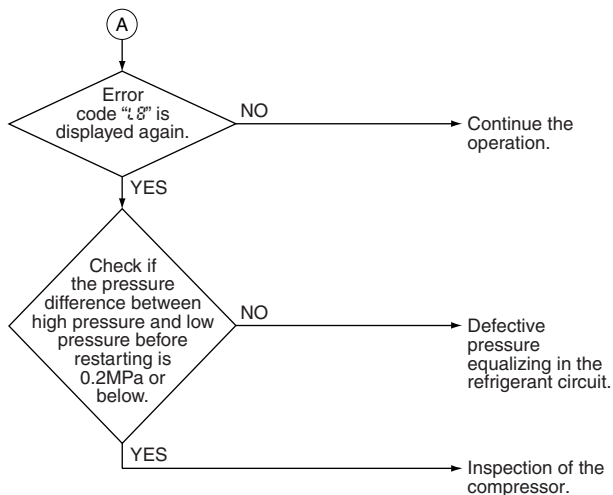

**CHECK 4** Refer to P.354.

## Remote Controller Display

**L8**

### Applicable Models

VRVII, -VII, II-S, -VIII, III-S and III-Q Series

### Method of Error Detection

Error is detected by current flowing in the power transistor.

### Error Decision Conditions

When overload in the compressor is detected.

### Supposed Causes

- Compressor overload
- Compressor coil disconnected
- Defective inverter PCB

## Troubleshooting

### Output current check



#### Caution

Be sure to turn off the power switch before connecting or disconnecting connectors, or parts may be damaged.

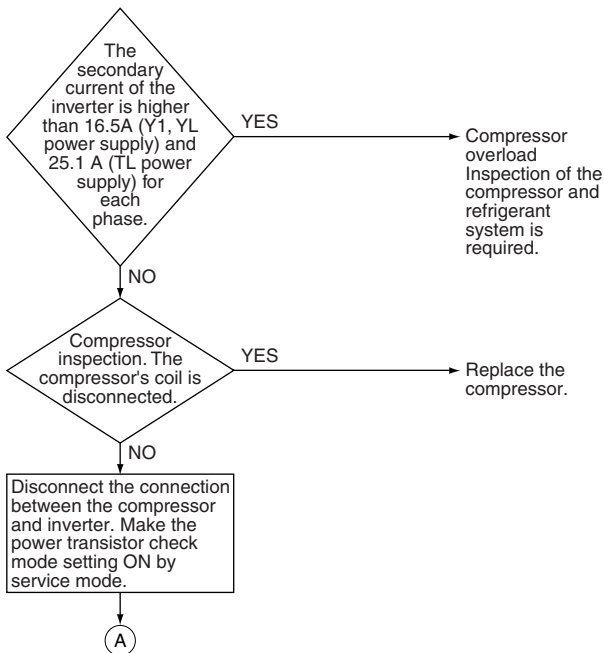

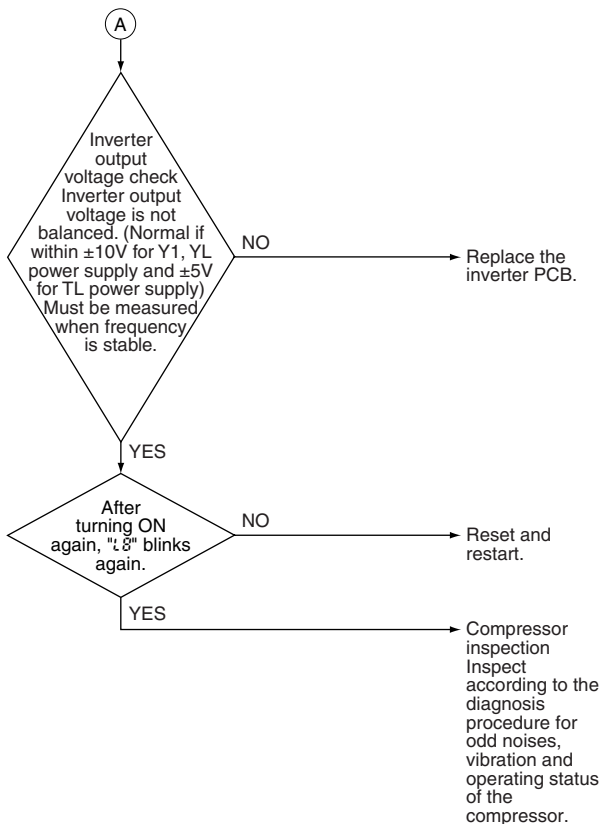

Higher voltage than actual is displayed when the inverter output voltage is checked by tester.

## 3.53 **L9** Inverter Compressor Startup Failure

### Remote Controller Display

**L9**

### Applicable Models

VRVIII Series

### Method of Error Detection

Detect the failure based on the signal waveform of the compressor.

### Error Decision Conditions

Starting the compressor does not complete.

### Supposed Causes

- Stop valve is not opened.
- Defective compressor
- Wiring connection error to the compressor
- Large pressure difference before starting the compressor
- Defective inverter PCB



## Troubleshooting



### Caution

Be sure to turn off the power switch before connecting or disconnecting connectors, or parts may be damaged.

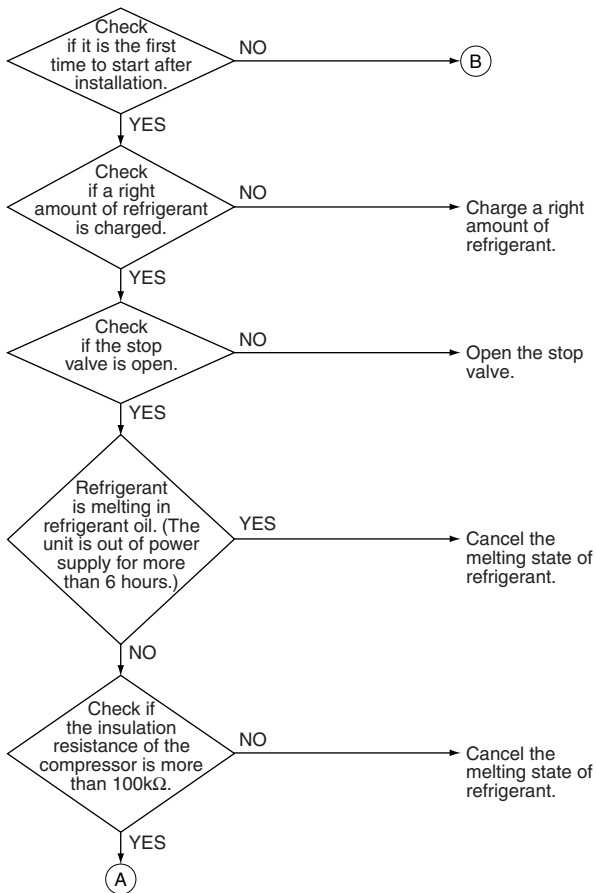

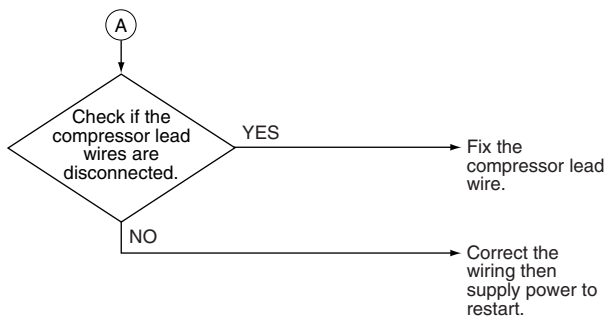

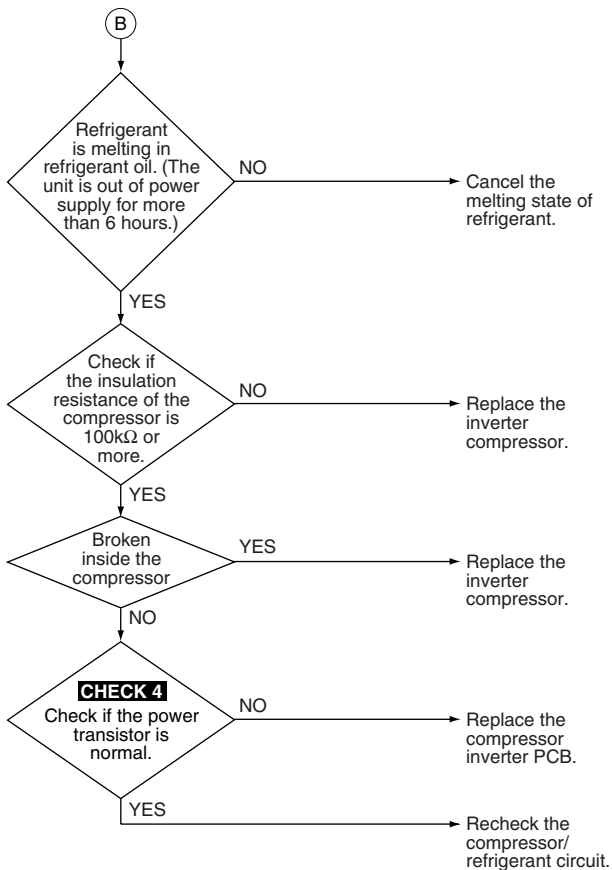

**CHECK 4** Refer to P.354.

## Remote Controller Display

**L9**

### Applicable Models

VRVII, -WII, II-S, -WIII, III-S and III-Q Series

### Method of Error Detection

Error is detected from current flowing in the power transistor.

### Error Decision Conditions

When overload in the compressor is detected during startup

### Supposed Causes

- Defective compressor
- Pressure differential start
- Defective inverter PCB

## Troubleshooting



### Caution

Be sure to turn off the power switch before connecting or disconnecting connectors, or parts may be damaged.

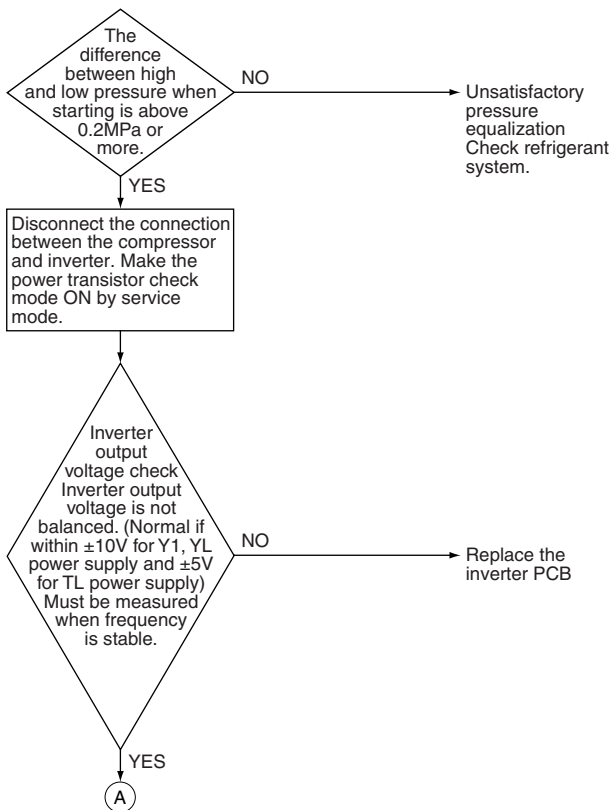

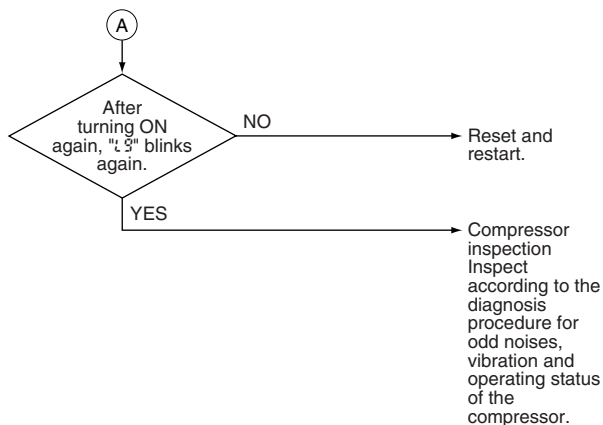

Higher voltage than actual is displayed when the inverter output voltage is checked by tester.

## 3.54 LL Transmission Error between Inverter and Control PCB

### Remote Controller Display



### Applicable Models

VRVIII and III-Q Series

### Method of Error Detection

Check the communication state between inverter PCB and control PCB by micro-computer.

### Error Decision Conditions

When the correct communication is not conducted in certain period or longer.

### Supposed Causes

- Defective connection between the inverter PCB and control PCB
- Defective control PCB (transmission section)
- Defective inverter PCB
- Defective noise filter
- Defective fan inverter
- Incorrect type of inverter PCB
- Defective inverter compressor
- Defective fan motor
- External factor (Noise etc.)

## Troubleshooting



### Caution

Be sure to turn off the power switch before connecting or disconnecting connectors, or parts may be damaged.

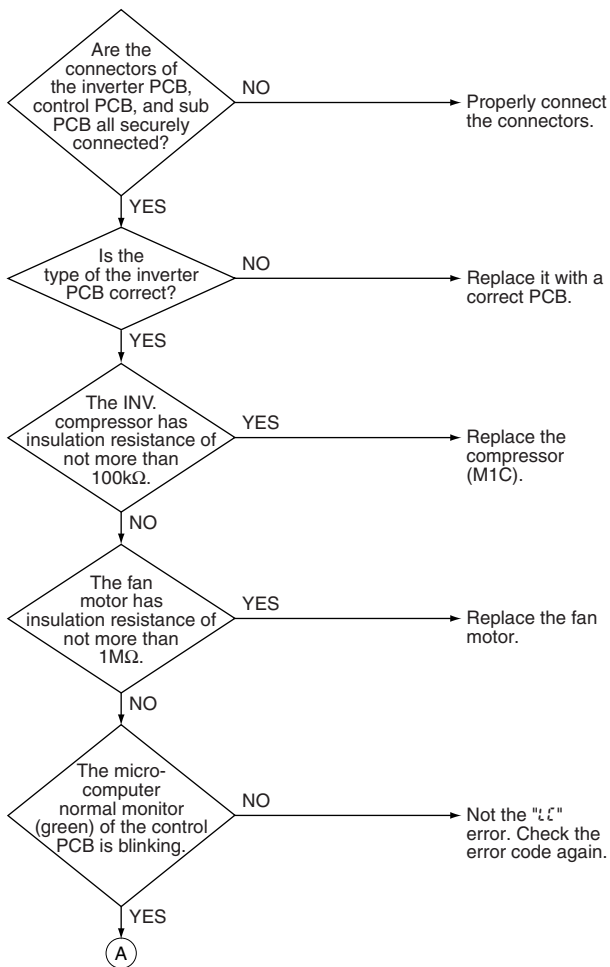



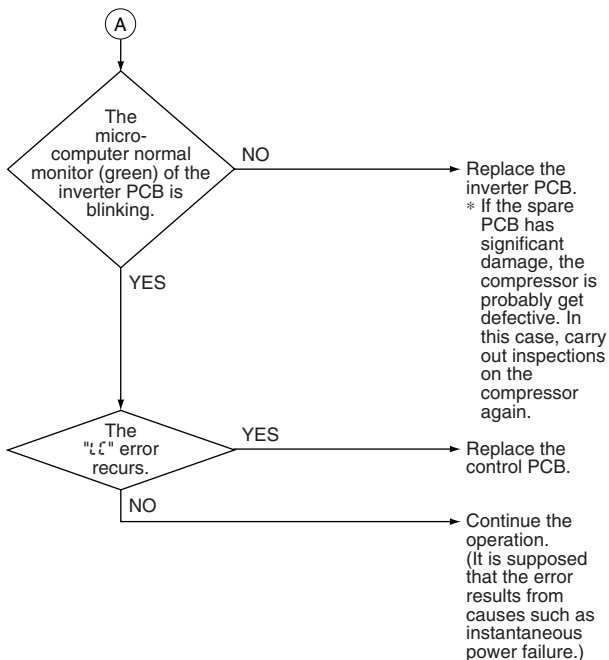

## Remote Controller Display



### Applicable Models

VRVII-S, III-S, -VII and -VIII Series

### Method of Error Detection

Check the communication state between inverter PCB and control PCB by micro-computer.

### Error Decision Conditions

When the correct communication is not conducted in certain period.

### Supposed Causes

- Defective connection between the inverter PCB and outdoor (outside) unit control PCB
- Defective outdoor (outside) unit control PCB (transmission section)
- Defective inverter PCB
- Defective noise filter
- External factor (Noise etc.)

## Troubleshooting



### Caution

Be sure to turn off the power switch before connecting or disconnecting connectors, or parts may be damaged.

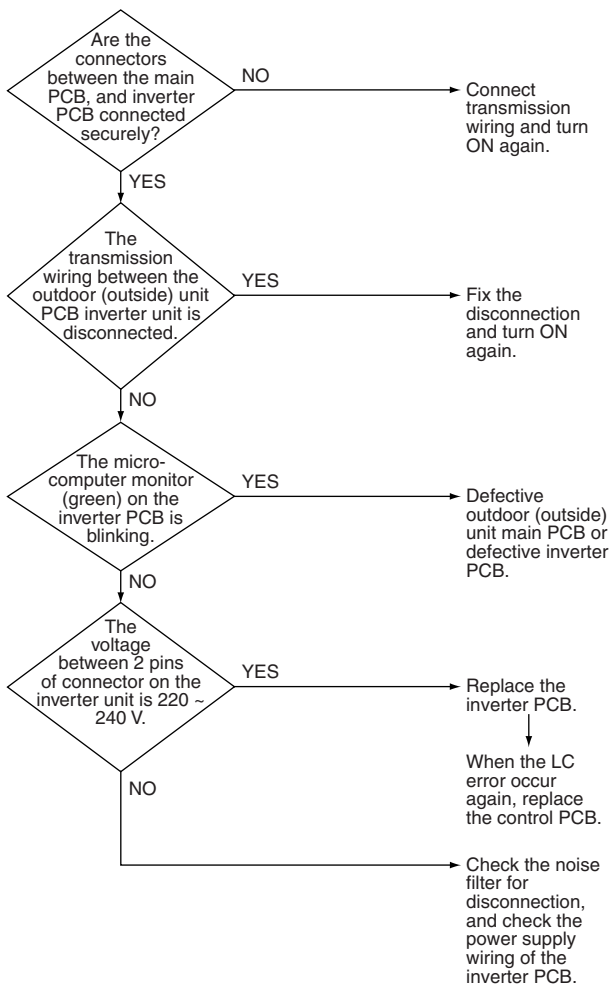

## Remote Controller Display



### Applicable Models

VRVII

### Method of Error Detection

Check the communication state between inverter PCB and control PCB by micro-computer.

### Error Decision Conditions

When the correct communication is not conducted in certain period.

### Supposed Causes

- Error of connection between the inverter PCB and outdoor unit control PCB
- Defective outdoor unit control PCB (transmission section)
- Defective inverter PCB
- Defective noise filter
- External factor (Noise etc.)

## Troubleshooting



### Caution

Be sure to turn off the power switch before connecting or disconnecting connectors, or parts may be damaged.

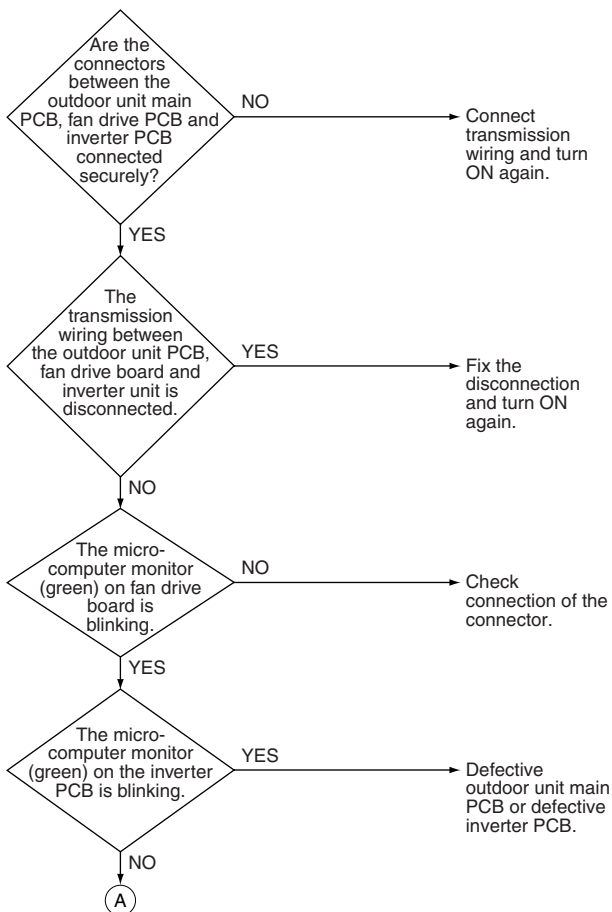

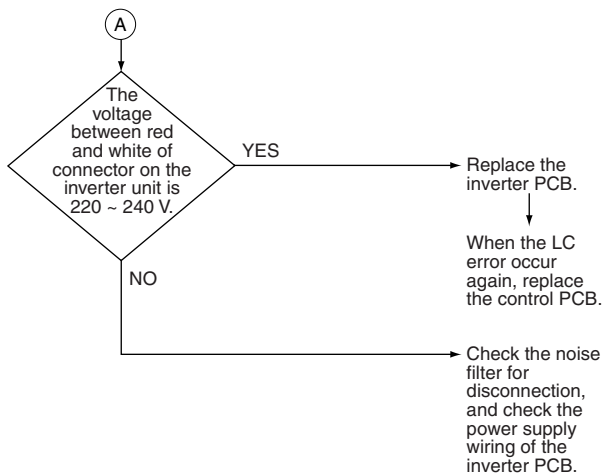

## 3.55 P I Inverter Over-Ripple Protection

### Remote Controller Display



### Applicable Models

VRVIII, -WIII, III-S and III-Q Series

### Method of Error Detection

Imbalance in supply voltage is detected in PCB.

Imbalance in the power supply voltage causes increased ripple of voltage of the main circuit capacitor in the inverter. Consequently, the increased ripple is detected.

### Error Decision Conditions

When the resistance value of thermistor becomes a value equivalent to open or short circuited status.

\* Error is not decided while the unit operation is continued.

"P I" will be displayed by pressing the INSPECTION button.

When the amplitude of the ripple exceeding a certain value is detected for consecutive 4 minutes.

### Supposed Causes

- Open phase
- Voltage imbalance between phases
- Defective main circuit capacitor
- Defective inverter PCB
- Defective relay in inverter PCB
- Improper main circuit wiring

## Troubleshooting



### Caution

Be sure to turn off the power switch before connecting or disconnecting connectors, or parts may be damaged.

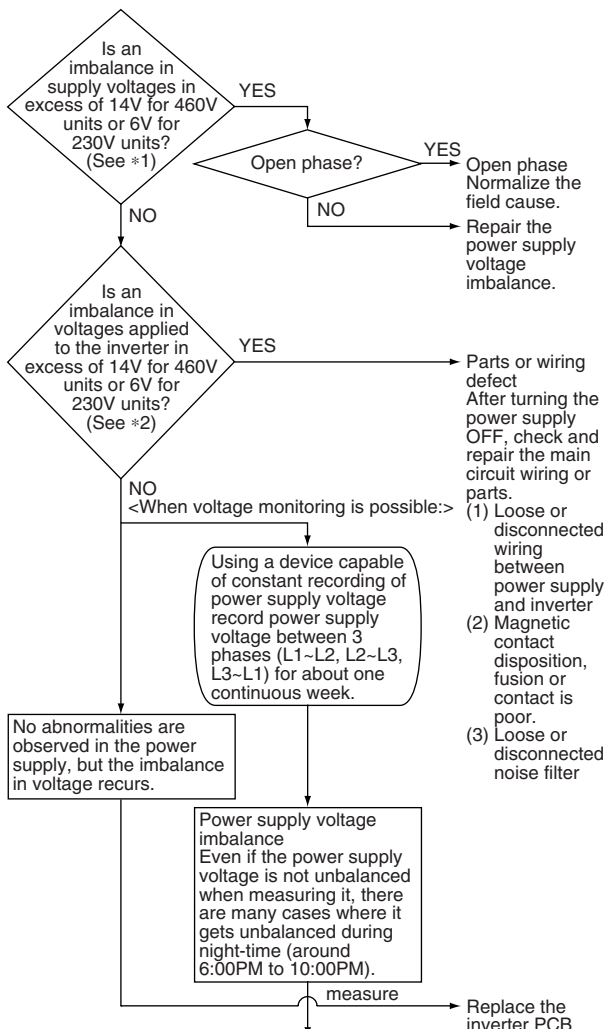



A

Explanation for users

\*In accordance with "notification of inspection results" accompanying spare parts.

Give the user a copy of "notification of inspection results" and leave it up to him to improve the imbalance.

Be sure to explain to the user that there is a "power supply imbalance" for which DAIKIN is not responsible.



**Note:**

- \*1. Measure voltage at the power supply terminal block.
- \*2. Measure voltage at terminals RED, WHITE and BLACK wire of the diode module inside the inverter while the compressor is running.

## Remote Controller Display

P1

### Applicable Models

VRVII and -VII Series

### Method of Error Detection

Imbalance in supply voltage is detected in PCB.

### Error Decision Conditions

When the resistance value of thermistor becomes a value equivalent to open or short circuited status.

- Error is not decided while the unit operation is continued.  
"P1" will be displayed by pressing the INSPECTION button.

### Supposed Causes

- Open phase
- Voltage imbalance between phases
- Defective main circuit capacitor
- Defective inverter PCB
- Defective magnetic contact switch
- Improper main circuit wiring

## Troubleshooting



### Caution

Be sure to turn off the power switch before connecting or disconnecting connectors, or parts may be damaged.

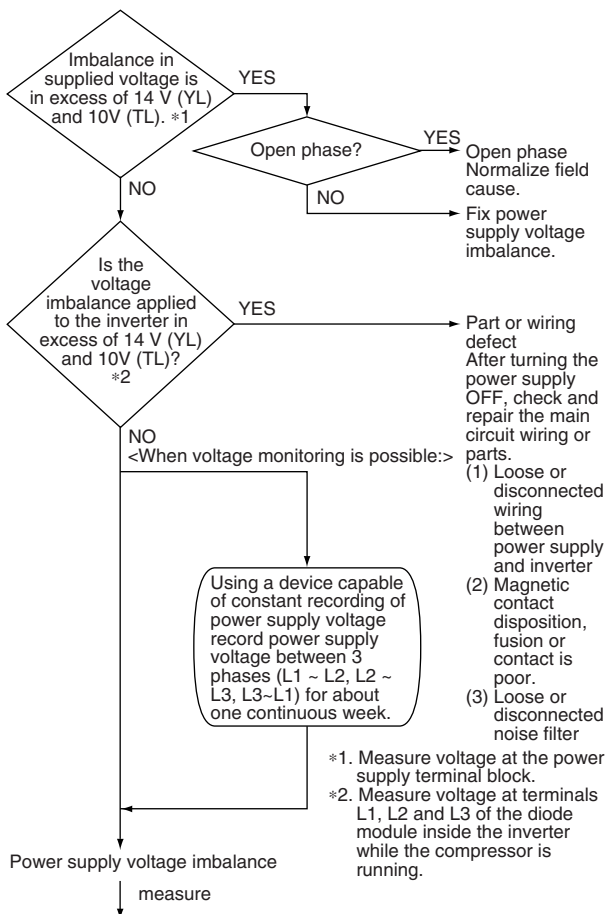

- (1) Loose or disconnected wiring between power supply and inverter
- (2) Magnetic contact disposition, fusion or contact is poor.
- (3) Loose or disconnected noise filter

\*1. Measure voltage at the power supply terminal block.

\*2. Measure voltage at terminals L1, L2 and L3 of the diode module inside the inverter while the compressor is running.

### Explanation for users

\*In accordance with "notification of inspection results" accompanying spare parts.

Give the user a copy of "notification of inspection results" and leave it up to him

Be sure to explain to the user that there is a "power supply imbalance"

## 3.56 P4 Inverter Radiation Fin Thermistor Abnormality

### Remote Controller Display

P4

### Applicable Models

VRVIII, III-S and III-Q Series

### Method of Error Detection

Resistance of radiation fin thermistor is detected when the compressor is not operating.

### Error Decision Conditions

When the resistance value of thermistor becomes a value equivalent to open circuited or short circuited status

\* Error is not decided while the unit operation is continued.

"P4" will be displayed by pressing the INSPECTION button.

### Supposed Causes

- Defective radiation fin thermistor
- Defective inverter PCB
- Defective inverter compressor
- Defective fan motor

## Troubleshooting



### Caution

Be sure to turn off the power switch before connecting or disconnecting connectors, or parts may be damaged.

Measure resistance value of the radiation fin thermistor.

### CHECK 11

\* Disconnect the connector from the radiation fin thermistor, and then check the thermistor.

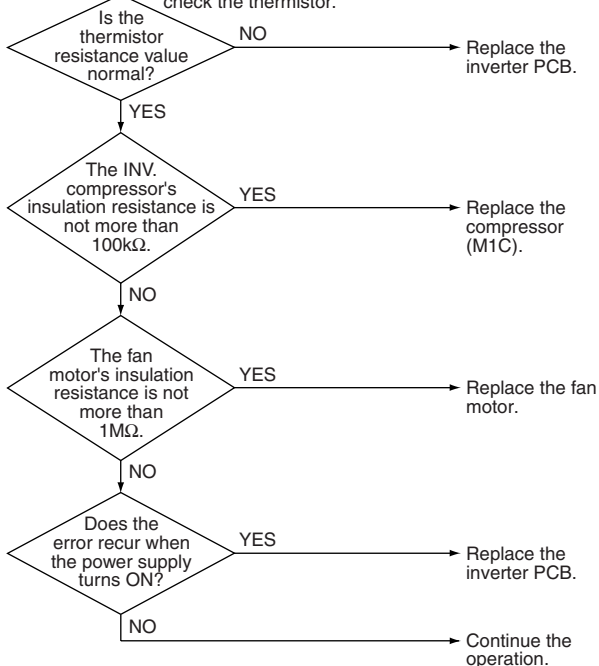

**CHECK 11** Refer to P.369.

## Remote Controller Display



### Applicable Models

VRVII, II-S, -WII and -WIII Series

### Method of Error Detection

Resistance of radiation fin thermistor is detected when the compressor is not operating.

### Error Decision Conditions

When the resistance value of thermistor becomes a value equivalent to open or short circuited status.

- Error is not decided while the unit operation is continued.

"P4" will be displayed by pressing the INSPECTION button.

### Supposed Causes

- Defective radiation fin thermistor
- Defective inverter PCB

## Troubleshooting



### Caution

Be sure to turn off the power switch before connecting or disconnecting connectors, or parts may be damaged.

Measure the resistance of radiation fin thermistor.

### CHECK 11

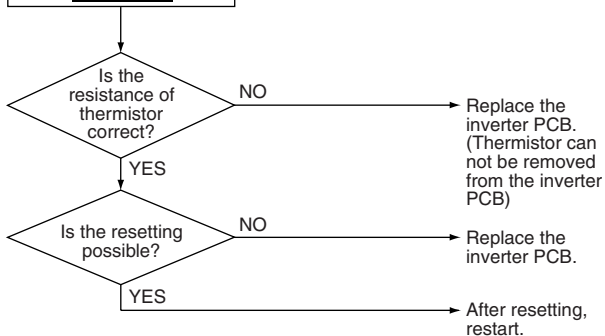

**CHECK 11** Refer to P.369.

## 3.57 P.U Field Setting Abnormality after Replacing Main PCB or Combination of PCB Abnormality

### Remote Controller Display

P.U

### Applicable Models

VRVIII Series

### Method of Error Detection

This error is detected according to communications with the inverter PCB.

### Error Decision Conditions

Make judgement according to communication data on whether or not the type of the inverter PCB is correct.

### Supposed Causes

- Defective (or no) field setting after replacing outdoor unit main PCB
- Mismatching of type of PCB



## Troubleshooting



### Caution

Be sure to turn off the power switch before connecting or disconnecting connectors, or parts may be damaged.

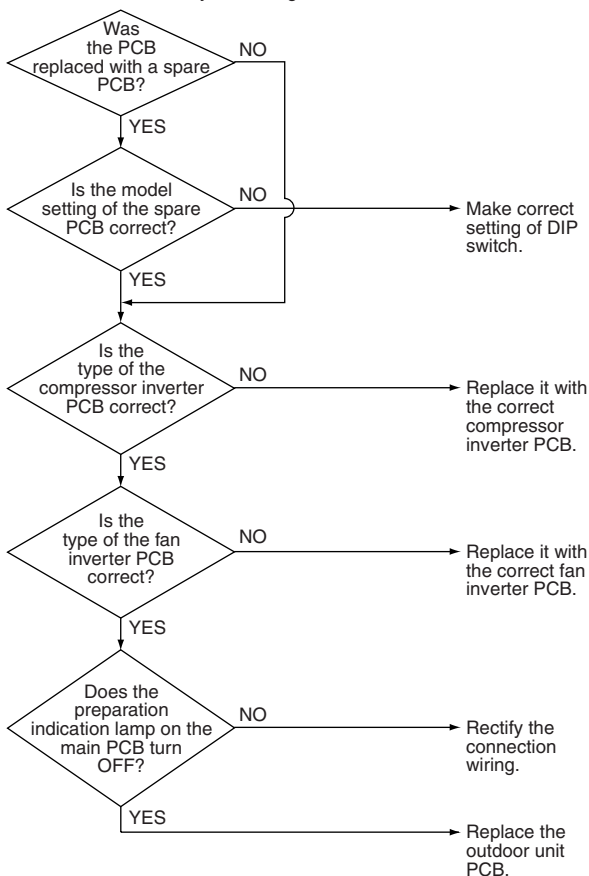

## Remote Controller Display

P1

### Applicable Models

VRVIII-Q Series

### Method of Error Detection

This error is detected according to communications with the INV. PCB.

### Error Decision Conditions

Make judgement according to communication data on whether or not the type of the INV. PCB is correct.

### Supposed Causes

- Mismatching of type of PCB
- Defective (or no) field setting after replacing main PCB

## Troubleshooting



### Caution

Be sure to turn off the power switch before connecting or disconnecting connectors, or parts may be damaged.

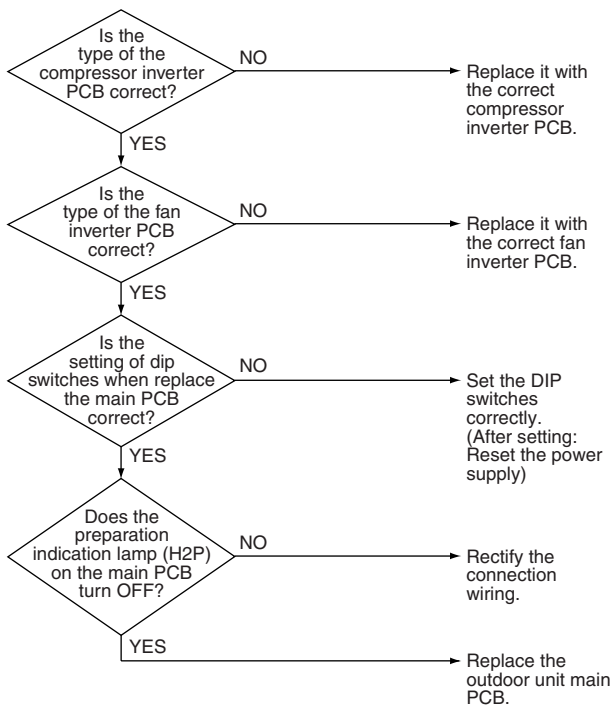

## Remote Controller Display

P1

### Applicable Models

VRVII Series

### Method of Error Detection

The defective (or no) field setting after replacing main PCB or defective PCB combination is detected through communications with the inverter.

### Error Decision Conditions

Whether or not the field setting or the type of the PCB is correct through the communication date is judged.

### Supposed Causes

- Defective (or no) field setting after replacing main PCB
- Mismatching of type of PCB

## Troubleshooting



### Caution

Be sure to turn off the power switch before connecting or disconnecting connectors, or parts may be damaged.

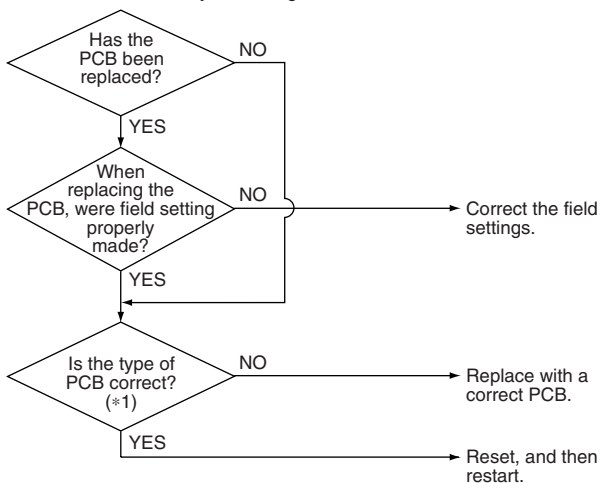

### Note:

- \*1. Type of PCB mismatching includes;
- Main PCB
  - Inverter PCB (for compressor)
  - Fan driver PCB

## Remote Controller Display

PU

### Applicable Models

VRVII-S Series

### Method of Error Detection

Check the communication state between inverter PCB and control PCB by micro-computer.

### Error Decision Conditions

When the communication data about inverter PCB type is incorrect.

### Supposed Causes

- Mismatching of inverter PCB
- Defective field setting

### Troubleshooting



#### Caution

Be sure to turn off the power switch before connecting or disconnecting connectors, or parts may be damaged.

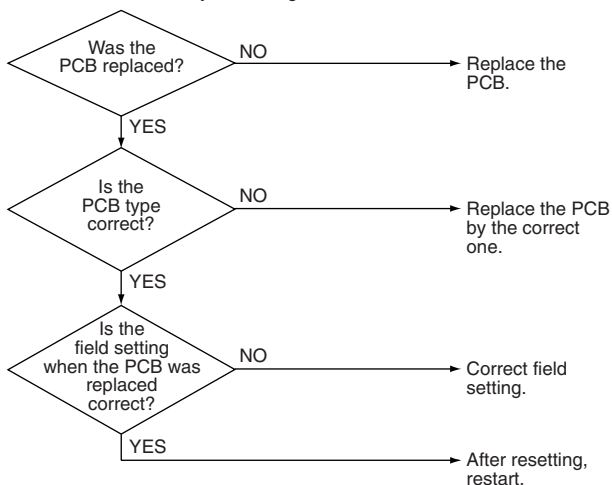

## 3.58 Refrigerant Shortage Alert

### Remote Controller Display



### Applicable Models

VRVIII, III-S and III-Q Series

### Method of Error Detection

Detect refrigerant shortage based on the temperature difference between low pressure or suction pipe and heat exchanger.

### Error Decision Conditions

[In cooling mode]

Low pressure becomes 0.1MPa or below.

[In heating mode]

The degree of superheat of suction gas becomes 20°C and over.

$$SH = Ts1 - Te$$

Ts1: Suction pipe temperature detected by thermistor

Te : Low pressure equivalent saturation temperature

\* Error is not determined. The unit continues the operation.

### Supposed Causes

- Refrigerant shortage or refrigerant clogging (piping error)
- Defective thermistor
- Defective low pressure sensor
- Defective outdoor unit PCB

## Troubleshooting



### Caution

Be sure to turn off the power switch before connecting or disconnecting connectors, or parts may be damaged.

### In cooling mode

- ① Set up a pressure gauge at the service port on the low pressure side.
- ② Reset the operation using the remote controller then restart.

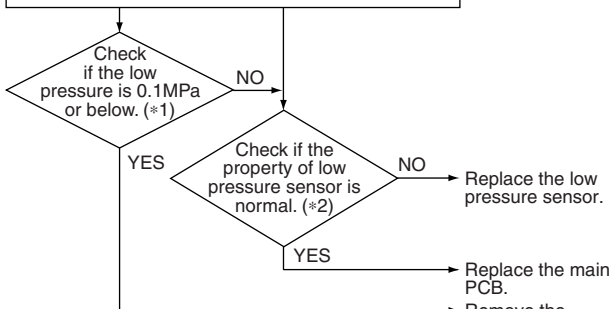

### In heating mode

Reset the operation using the remote controller then restart.

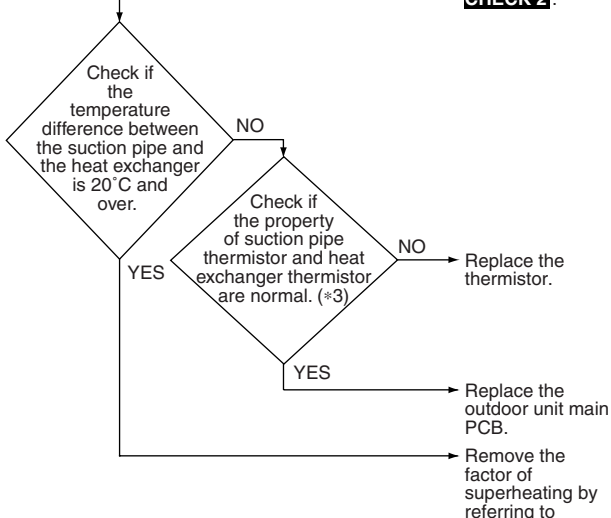





**Note:**

- \*1. Check the low pressure value by using pressure gauge in operation.
- \*2. Compare the actual measurement value by pressure sensor with the value by the pressure gauge.  
(To gain actual measurement value by pressure sensor, measure the voltage at the connector [between (2)-(3)] and then convert the value into pressure **CHECK 12** .)
- \*3. Compare the thermistor resistance value with the value on the surface thermometer.



**CHECK 2** Refer to P.348.



**CHECK 3** Refer to P.351.



**CHECK 12** Refer to P.372.

## Remote Controller Display



### Applicable Models

VRV-WII and -WIII Series

### Method of Error Detection

Detect refrigerant shortage using low pressure or difference in temperature between the suction pipe and the heat exchanger.

### Error Decision Conditions

#### In cooling

- Low pressure of 0.25 MPa or less continues for 30 minutes

#### In heating

- Suction gas superheated degree of 20°C or more continues for 60 minutes.

\* Abnormality is not confirmed and operation is continued.

### Supposed Causes

- Refrigerant shortage or clogged refrigerant (wrong piping)
- Defective thermistor
- Defective low pressure sensor
- Defective main PCB

## Troubleshooting



### Caution

Be sure to turn off the power switch before connecting or disconnecting connectors, or parts may be damaged.

### In cooling

- ① Set up a pressure gauge in the service port on the low pressure side.
- ② Connect the Service Checker.
- ③ Reset operation with a remote controller and restart operation.

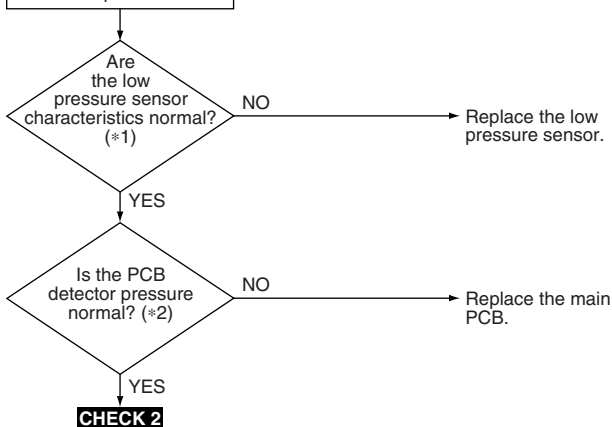

### Note:

- \*1: Compare pressure sensor measurements with pressure gauge readings.  
(For measurements by a pressure sensor, measure voltage between connectors (2) and (3) and convert it to pressure in accordance with **CHECK 12** .)
- \*2: Compare low pressure measured by the Service Checker with pressure sensor measurements (\*1).

## In heating

- ① Connect the Service Checker.
- ② After resetting operation with a remote controller, restart operation.

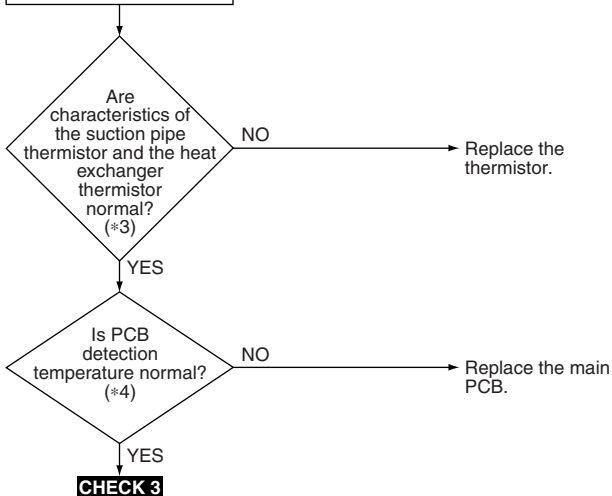

### Note:

- \*3: Compare the thermistor resistance with surface thermostat measurements.
- \*4: Compare the suction pipe temperature checked by the Service Checker with measurements obtained in \*3 above.



**CHECK 2** Refer to P.348.



**CHECK 3** Refer to P.351.



**CHECK 12** Refer to P.372.

## Remote Controller Display



## Applicable Models

VRVII and II-S Series

## Method of Error Detection

Shortage of refrigerant is detected by discharge pipe thermistor.

## Error Decision Conditions

Micro-computer judge and detect if the system is refrigerant shortage.

\* Error is not decided while the unit operation is continued.

## Supposed Causes

- Shortage of gas or refrigerant system clogging (incorrect piping)
- Defective pressure sensor
- Defective outdoor unit PCB
- Defective thermistor

## Troubleshooting



### Caution

Be sure to turn off the power switch before connecting or disconnecting connectors, or parts may be damaged.

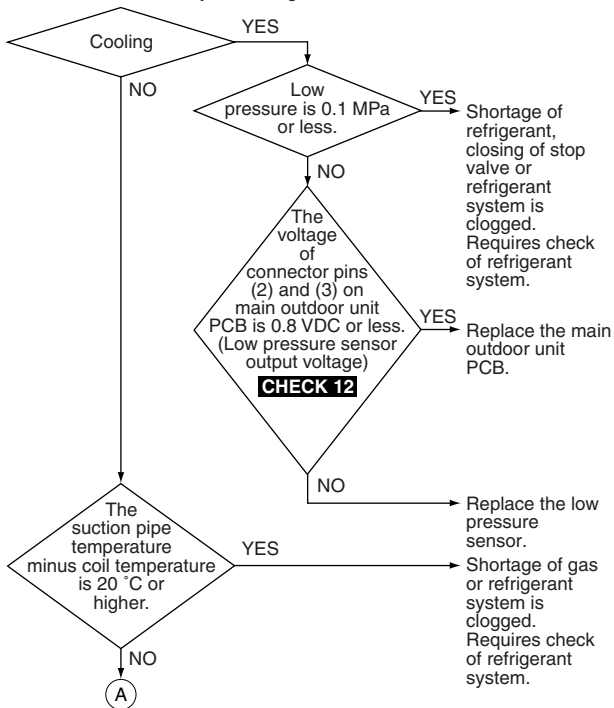

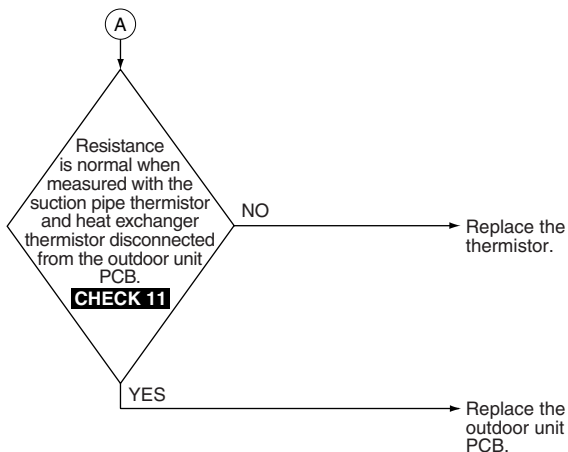

**CHECK 11** Refer to P.369.



**CHECK 12** Refer to P.372.

## 3.59 Reverse Phase, Open Phase

### Remote Controller Display



### Applicable Models

VRVII, III, -WII, -WIII and III-Q Series

### Method of Error Detection

The phase of each phase are detected by reverse phase detection circuit and right phase or reverse phase are judged.

### Error Decision Conditions

When a power supply is reverse phase, or T phase is open phase.

### Supposed Causes

- Power supply reverse phase
- Power supply open phase
- Defective outdoor (outside) unit PCB



## Troubleshooting



### Caution

Be sure to turn off the power switch before connecting or disconnecting connectors, or parts may be damaged.

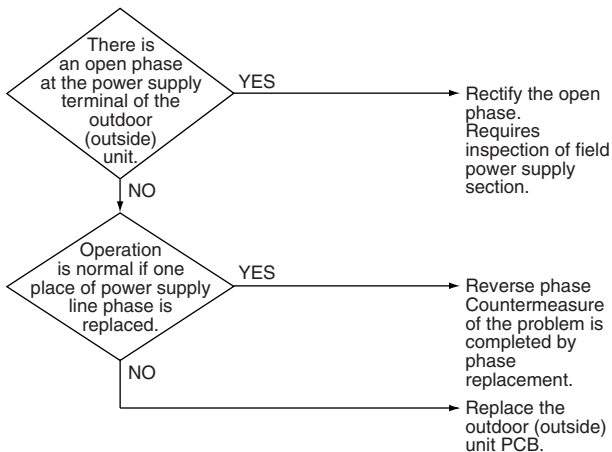

## 3.60 U2 Power Supply Insufficient or Instantaneous Error

### Remote Controller Display

U2

### Applicable Models

VRVIII Series

### Method of Error Detection

Detection of voltage of main circuit capacitor built in the inverter and power supply voltage.

### Error Decision Conditions

When the voltage aforementioned is not less than 780V or not more than 320V, or when the current-limiting voltage does not reach 200V or more or exceeds 740V  
For 230V units: When the voltage aforementioned is not more than 190V

### Supposed Causes

- Power supply insufficient
- Instantaneous power failure
- Open phase
- Defective inverter PCB
- Defective control PCB
- Defective main circuit wiring
- Defective compressor
- Defective fan motor
- Defective connection of signal cable

## Troubleshooting



### Caution

Be sure to turn off the power switch before connecting or disconnecting connectors, or parts may be damaged.

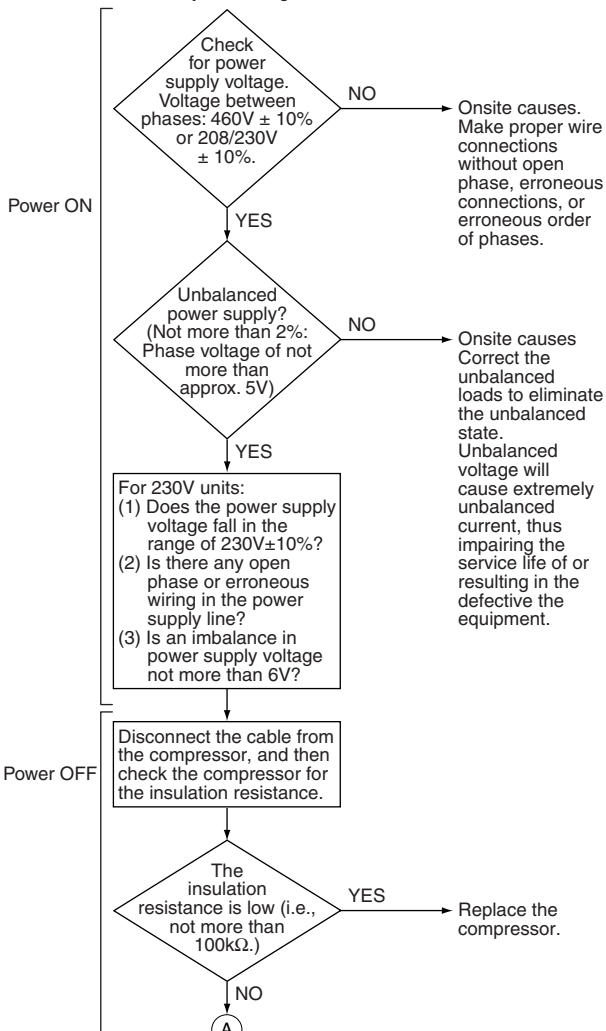

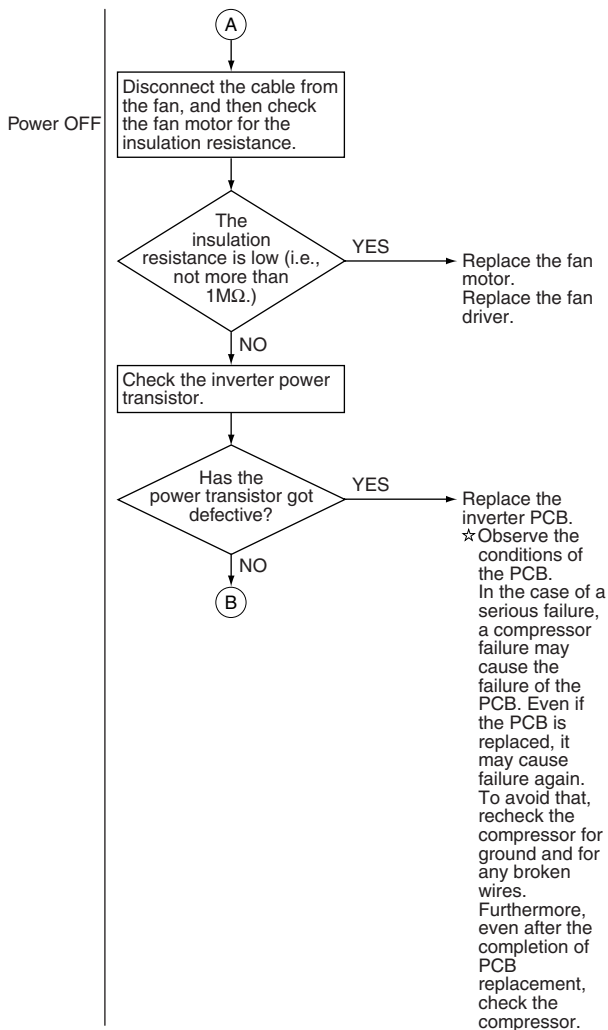

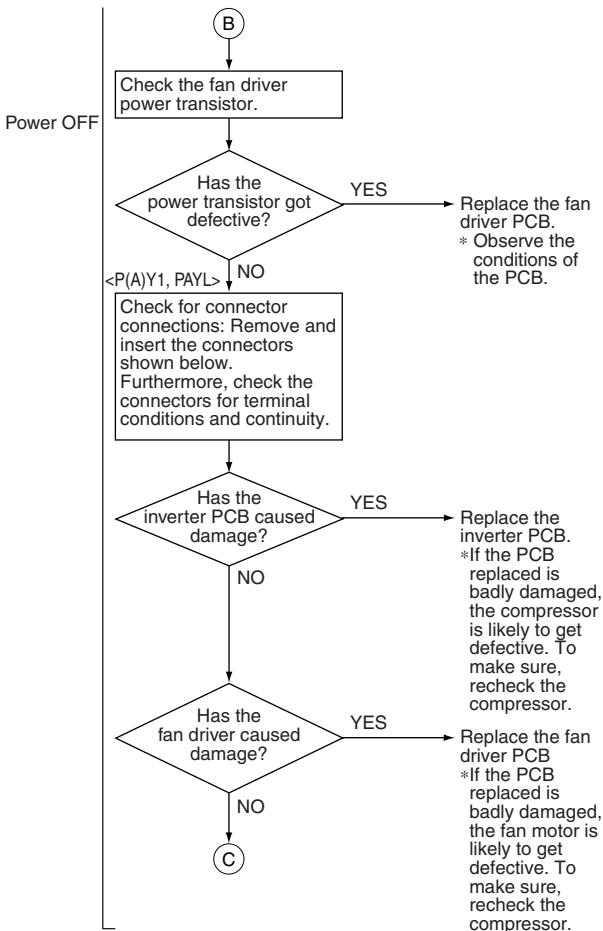

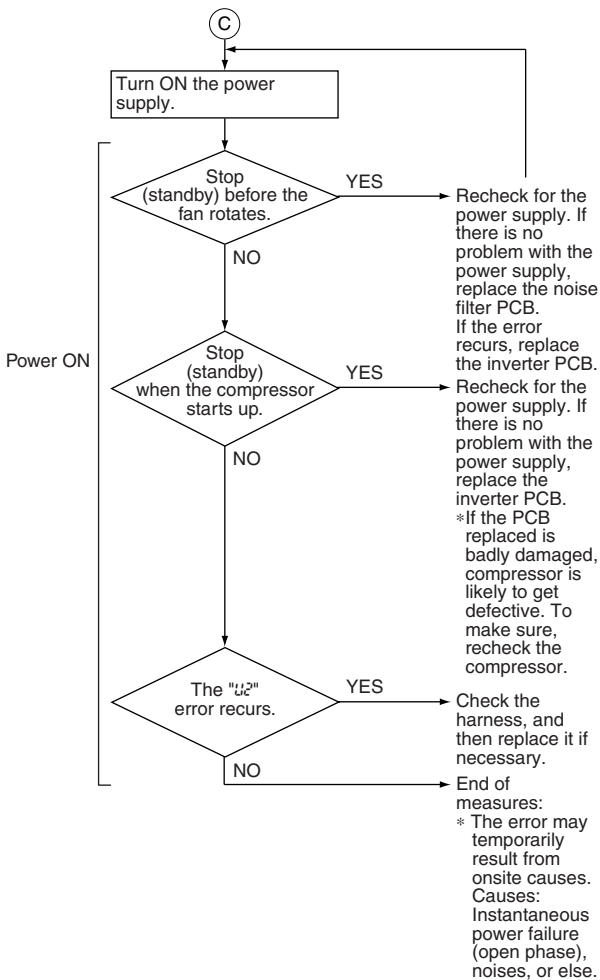

## Remote Controller Display



## Applicable Models

VRVIII-Q Series

## Method of Error Detection

Detection of voltage of main circuit capacitor built in the inverter PCB and power supply voltage.

## Error Decision Conditions

When the voltage aforementioned is not less than 190V.

## Supposed Causes

- Power supply insufficient
- Instantaneous power failure
- Open phase
- Defective inverter PCB
- Defective outdoor control PCB
- Defective compressor
- Defective main circuit wiring
- Defective fan motor
- Defective connection of signal cable

## Troubleshooting



### Caution

Be sure to turn off the power switch before connecting or disconnecting connectors, or parts may be damaged.

Check the condition of the power supply.

- ① Check if power supply voltage is 380 to 415V.
- ② Check if there is open phase or wrong wiring.
- ③ Check if power supply voltage side unbalance is within 6V.

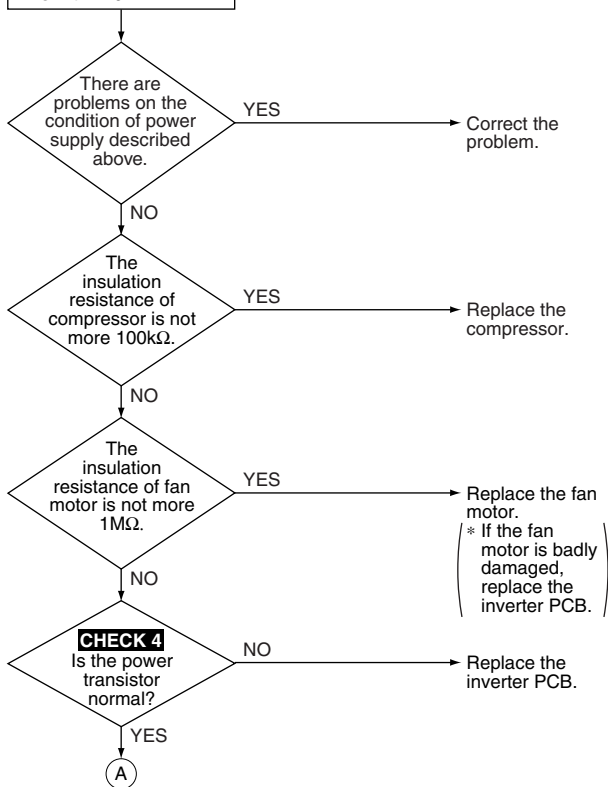



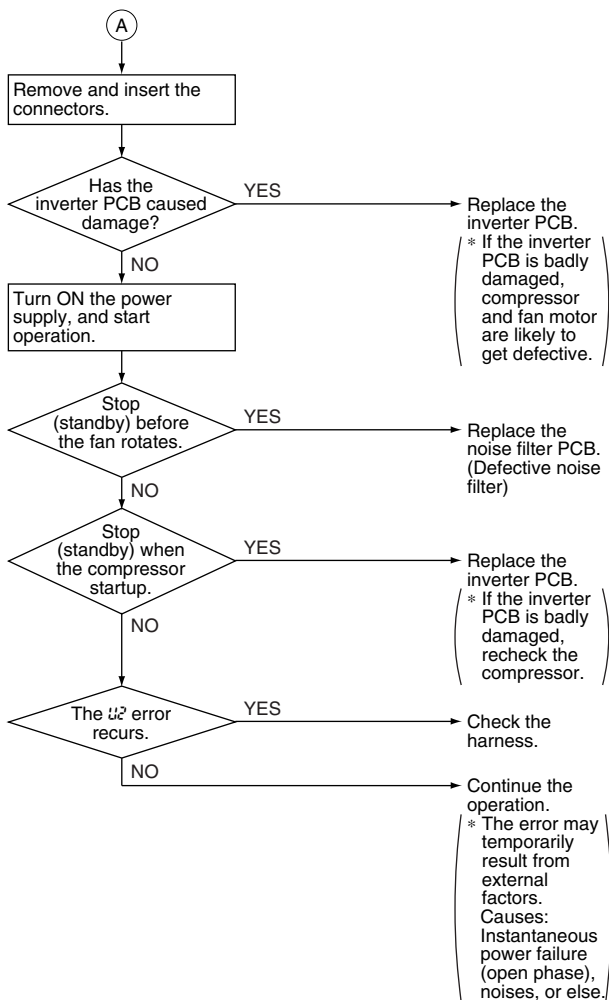

**CHECK 4** Refer to P.354.

## Remote Controller Display



### Applicable Models

VRV-WIII Series

### Method of Error Detection

Detection of voltage of main circuit capacitor built in the inverter and power supply voltage.

### Error Decision Conditions

When the capacitor above only has a voltage of 360 V or less (YL) and 210V or less (TL).

### Supposed Causes

- Power supply insufficient
- Instantaneous failure
- Open phase
- Defective inverter PCB
- Defective outside control PCB
- Defective magnetic contact switch.
- Defective main circuit wiring

## Troubleshooting



### Caution

Be sure to turn off the power switch before connecting or disconnecting connectors, or parts may be damaged.

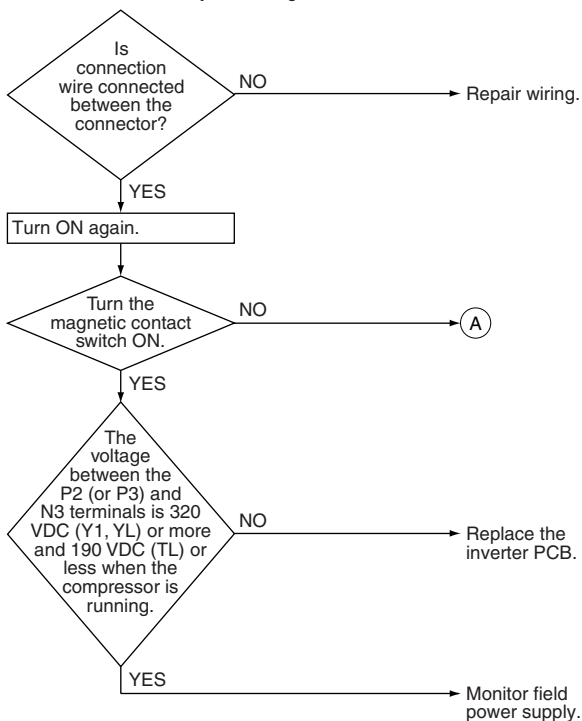

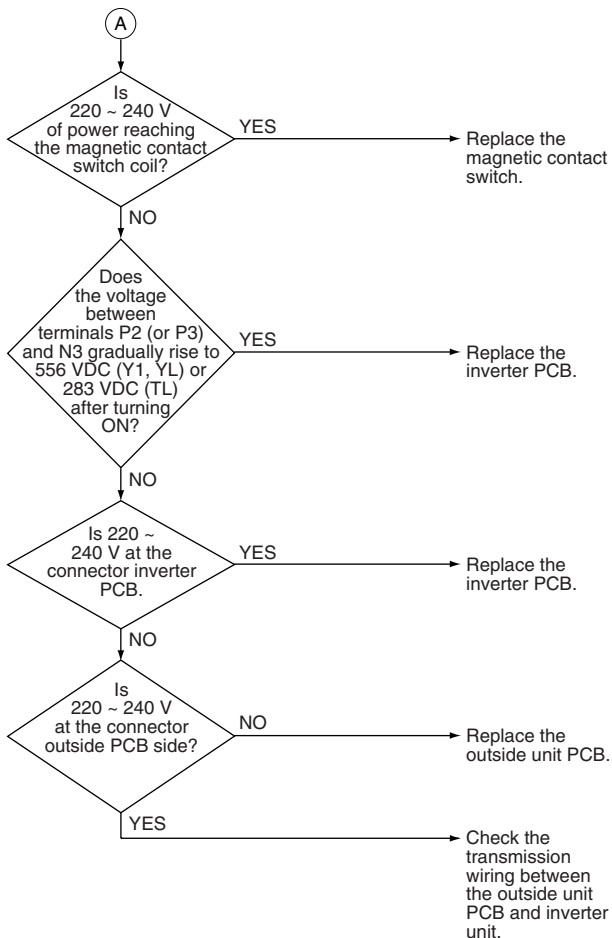

## Remote Controller Display



## Applicable Models

VRVIII-S Series

## Method of Error Detection

Detection of voltage of main circuit capacitor built in the inverter and power supply voltage.

## Error Decision Conditions

When the voltage aforementioned is not less than 780V or not more than 320V, or when the current-limiting voltage does not reach 200V or more or exceeds 740V.

## Supposed Causes

- Power supply insufficient
- Instantaneous power failure
- Open phase
- Defective outdoor unit control PCB
- Defective main circuit wiring
- Defective compressor
- Defective fan motor
- Defective connection of signal cable

## Troubleshooting



### Caution

Be sure to turn off the power switch before connecting or disconnecting connectors, or parts may be damaged.

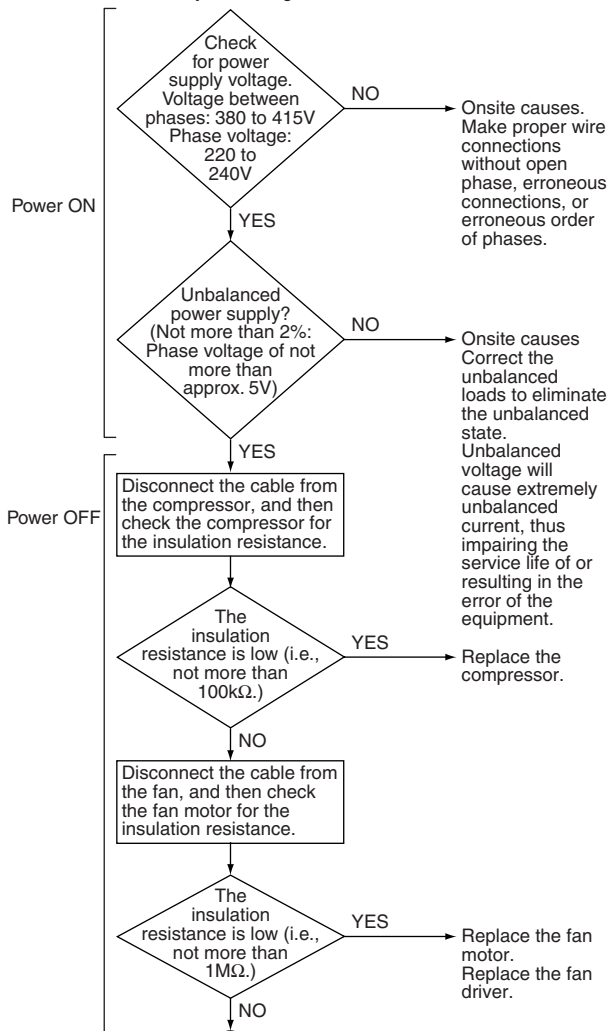

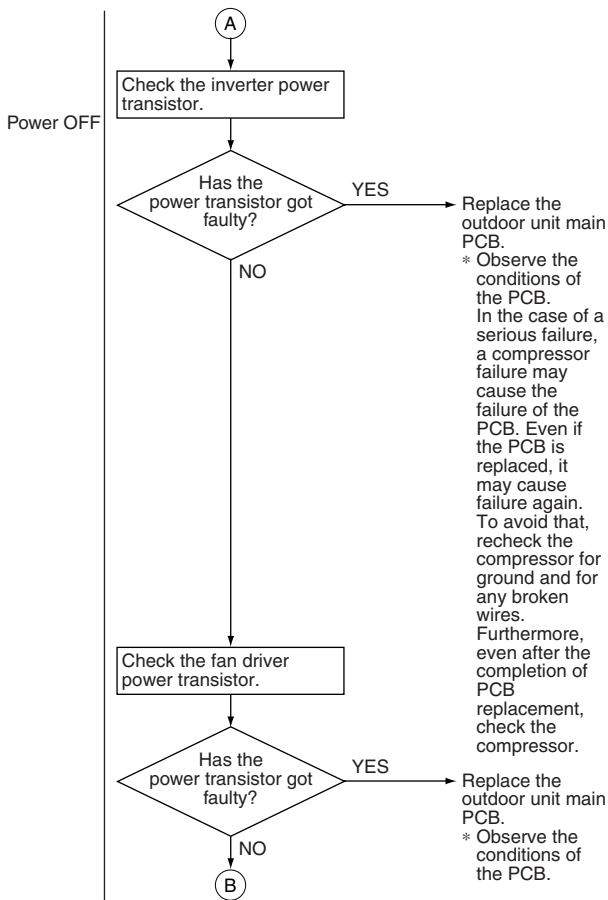

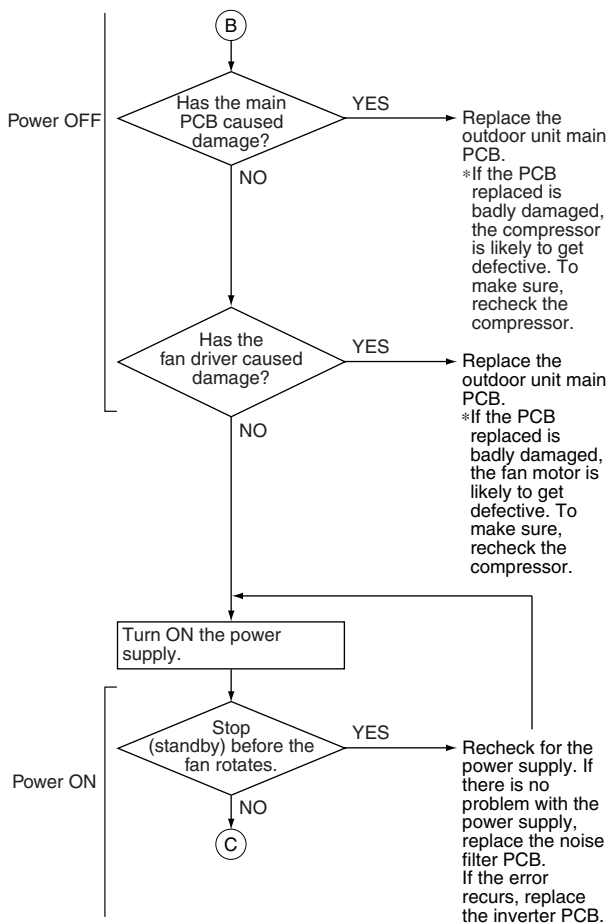



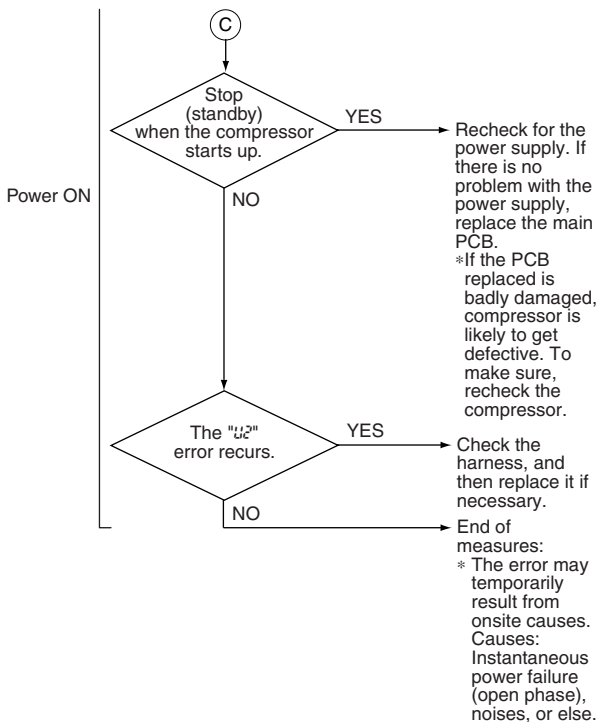

## Remote Controller Display



### Applicable Models

VRVII and -VII Series

### Method of Error Detection

Detection of voltage of main circuit capacitor built in the inverter and power supply voltage.

### Error Decision Conditions

When the capacitor above only has a voltage of 360 V or less (YL) and 210V or less (TL).

### Supposed Causes

- Power supply insufficient
- Instantaneous failure
- Open phase
- Defective inverter PCB
- Defective outdoor (outside) control PCB
- Defective magnetic contact switch.
- Defective main circuit wiring

## Troubleshooting



### Caution

Be sure to turn off the power switch before connecting or disconnecting connectors, or parts may be damaged.

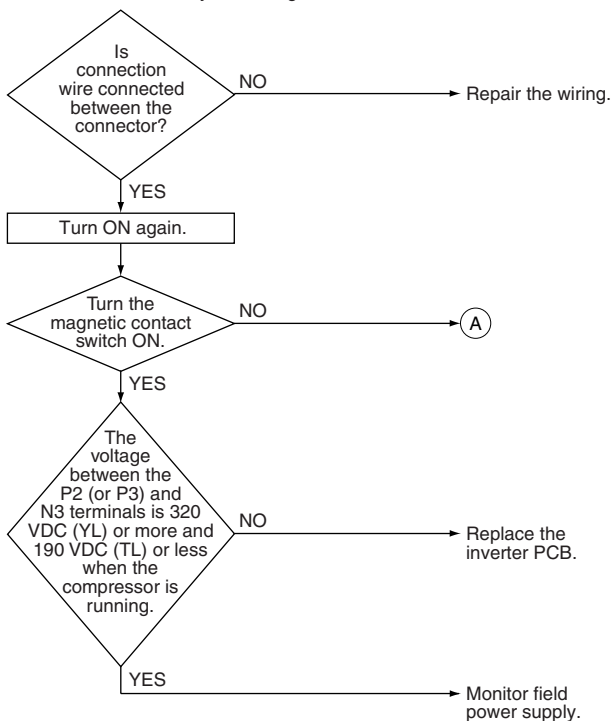

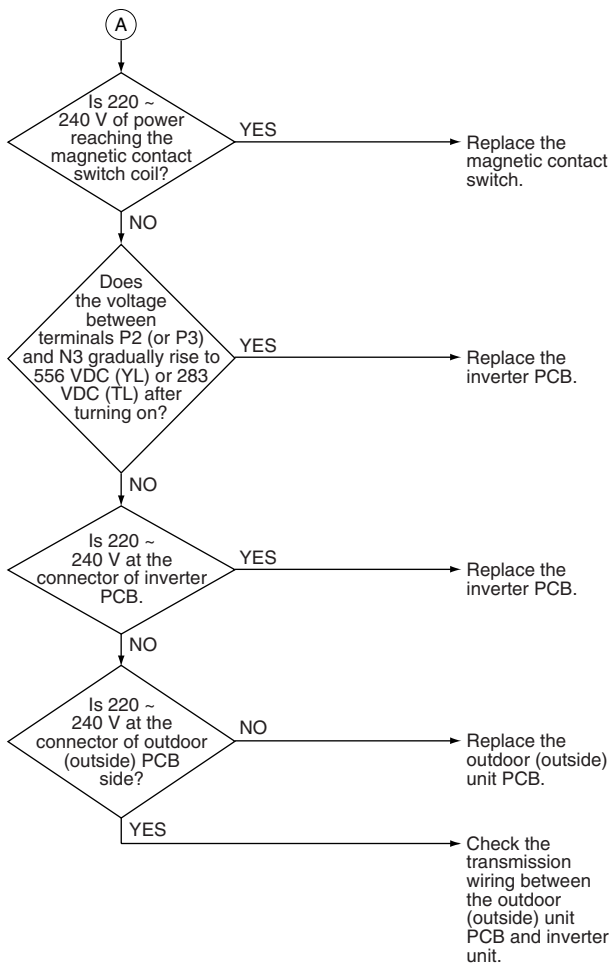

## Remote Controller Display



## Applicable Models

VRVII-S Series

## Method of Error Detection

Detection of voltage of main circuit capacitor built in the inverter and power supply voltage.

## Error Decision Conditions

## Supposed Causes

- Power supply insufficient
- Instantaneous failure
- Defective inverter PCB
- Defective outdoor control PCB
- Defective main circuit wiring

## Troubleshooting



### Caution

Be sure to turn off the power switch before connecting or disconnecting connectors, or parts may be damaged.

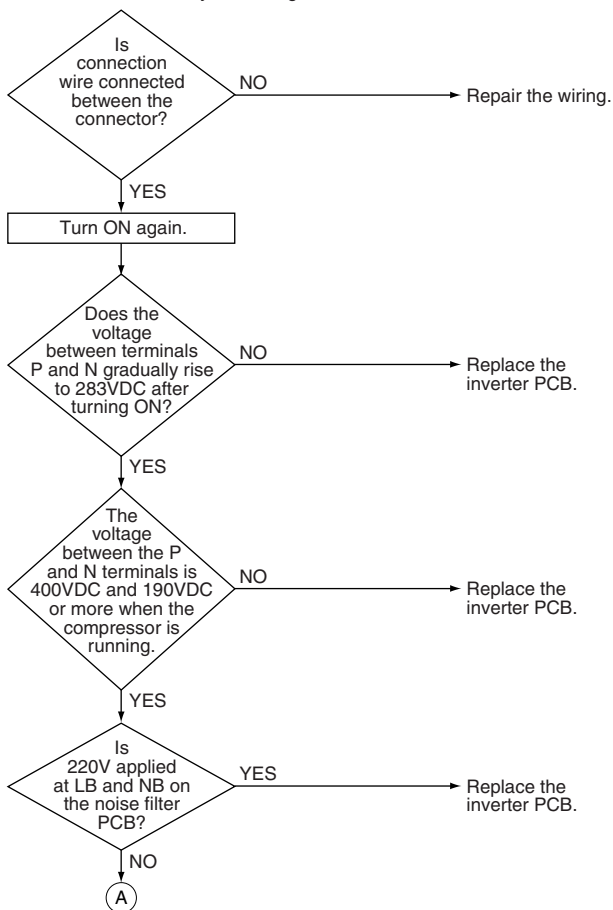

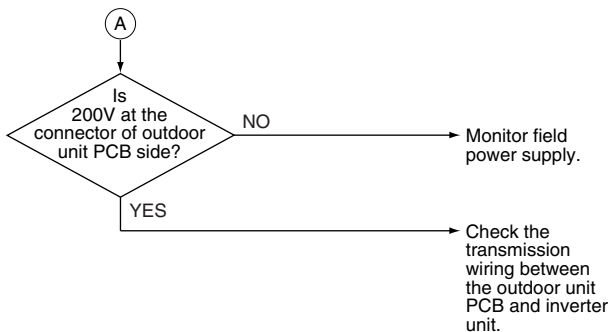

## 3.61 U3 Check Operation is not Executed

### Remote Controller Display

U3

### Applicable Models

All outdoor unit series

### Method of Error Detection

Check operation is executed or not executed.

### Error Decision Conditions

Error is decided when the unit starts operation without check operation.

### Supposed Causes

- Check operation is not executed.



## Troubleshooting



### Caution

Be sure to turn off the power switch before connecting or disconnecting connectors, or parts may be damaged.

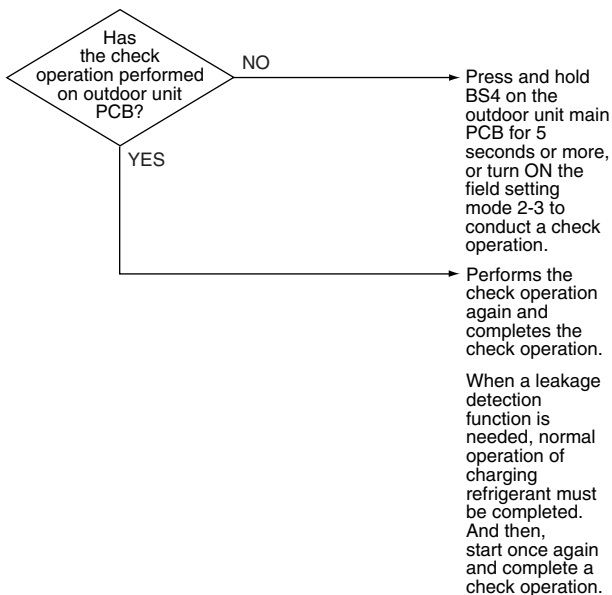

## 3.62 Transmission Error between Indoor Units and Outdoor Units

### Remote Controller Display



### Applicable Models

All indoor models  
VRVIII Series

### Method of Error Detection

Micro-computer checks if transmission between indoor and outdoor units is normal.

### Error Decision Conditions

When transmission is not carried out normally for a certain amount of time

### Supposed Causes

- Indoor to outdoor, outdoor to outdoor transmission wiring F1, F2 disconnection, short circuit or wrong wiring
- Outdoor unit power supply is OFF
- System address does not match
- Defective indoor unit PCB
- Defective outdoor unit PCB

## Troubleshooting



### Caution

Be sure to turn off the power switch before connecting or disconnecting connectors, or parts may be damaged.

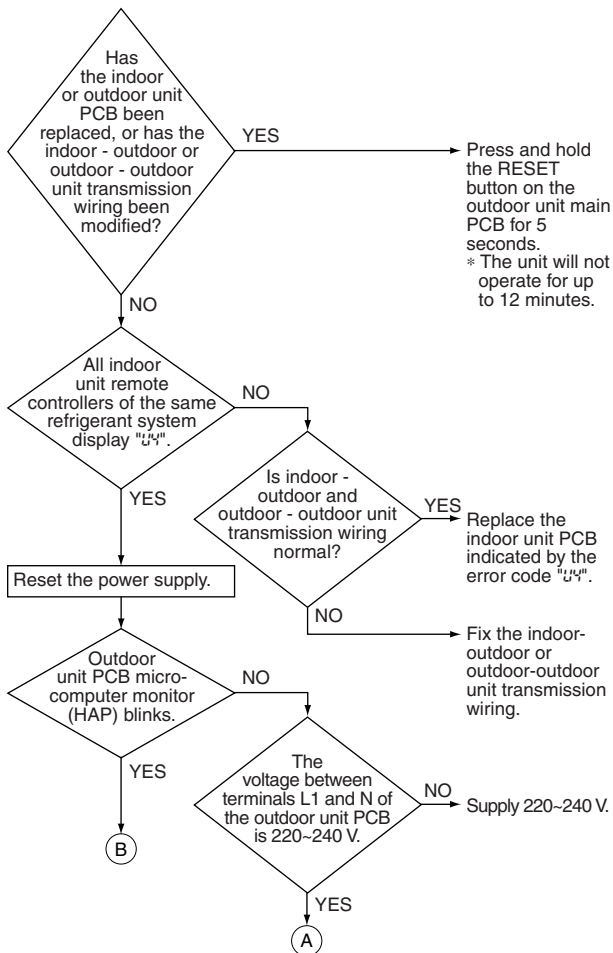

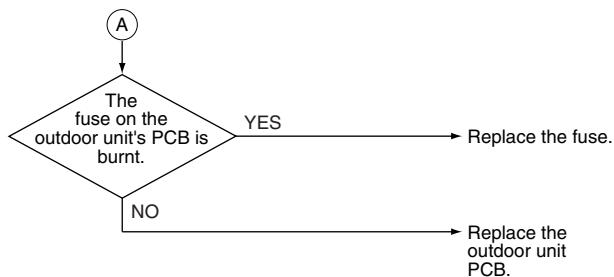

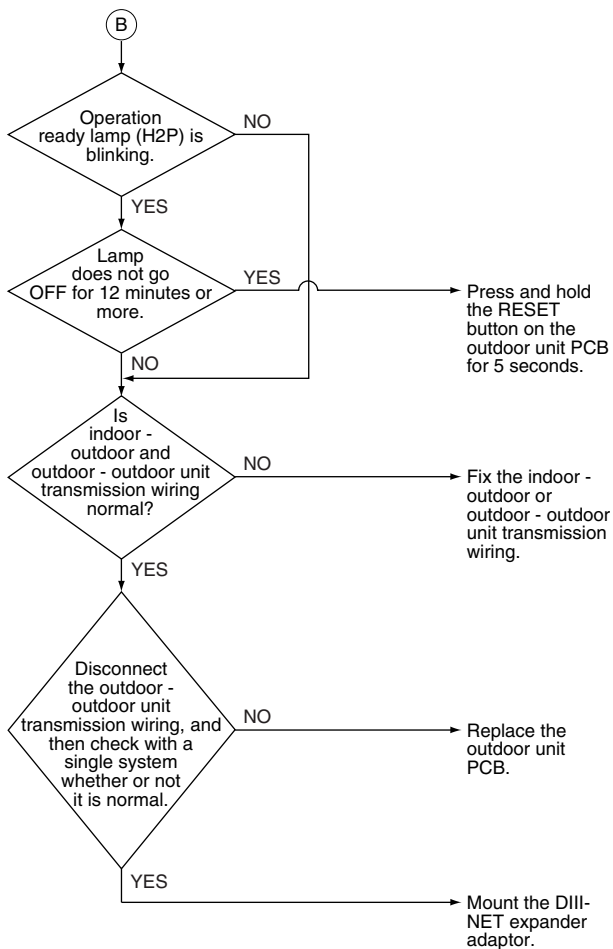

## Remote Controller Display



### Applicable Models

All indoor models  
VRVIII-S and III-Q Series

### Method of Error Detection

The error is generated when the micro-computer detects that the transmission between the indoor and outdoor unit is not normal.

### Error Decision Conditions

When transmission is not carried out normally for a certain amount of time

### Supposed Causes

- Indoor to outdoor, outdoor to outdoor transmission wiring F1, F2 disconnection, short circuit or wrong wiring
- Outdoor unit power supply is OFF
- System address does not match
- Defective outdoor unit main PCB
- Defective indoor unit PCB

## Troubleshooting



### Caution

Be sure to turn off the power switch before connecting or disconnecting connectors, or parts may be damaged.

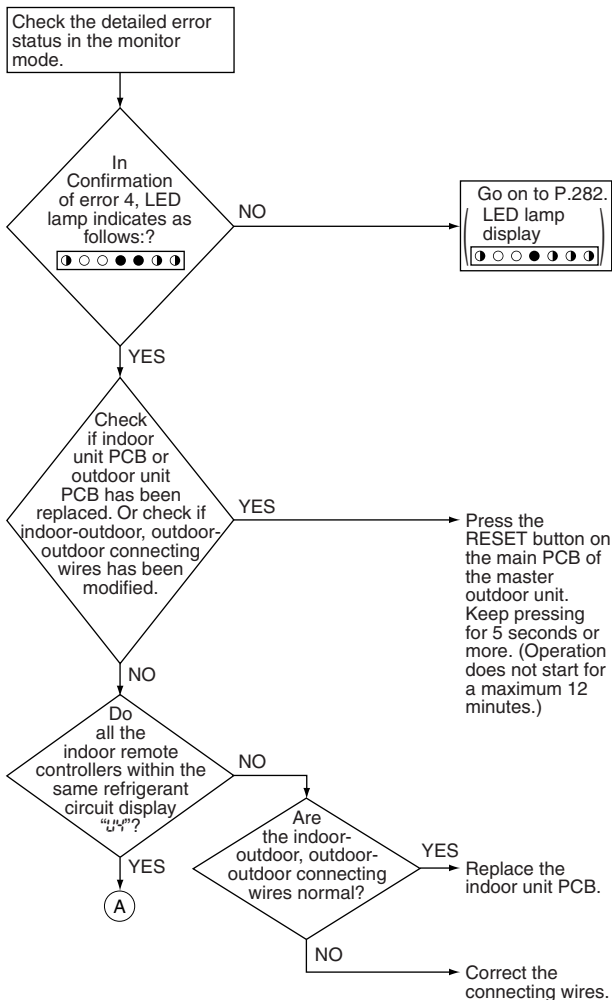

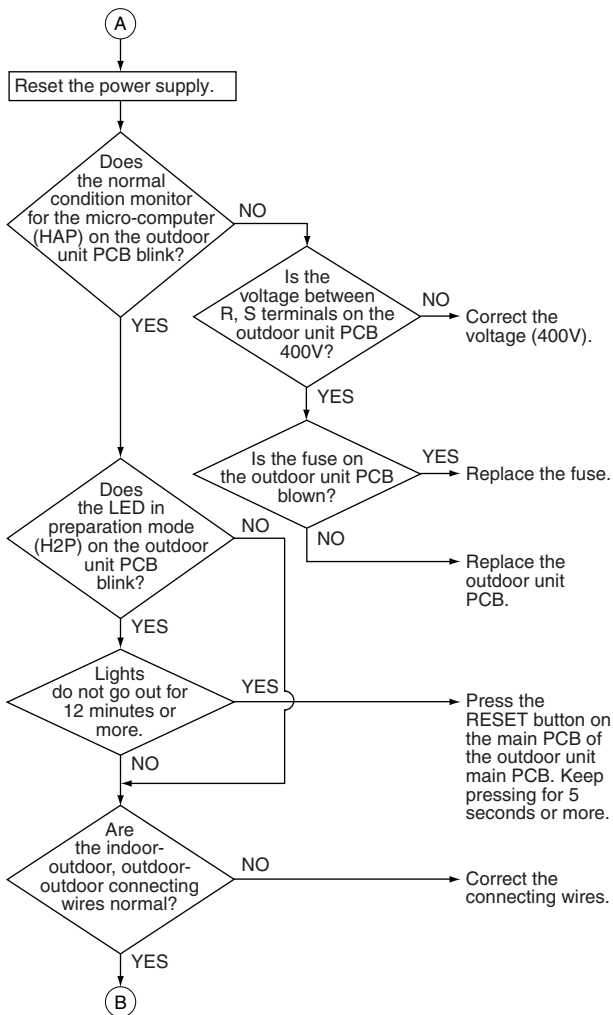



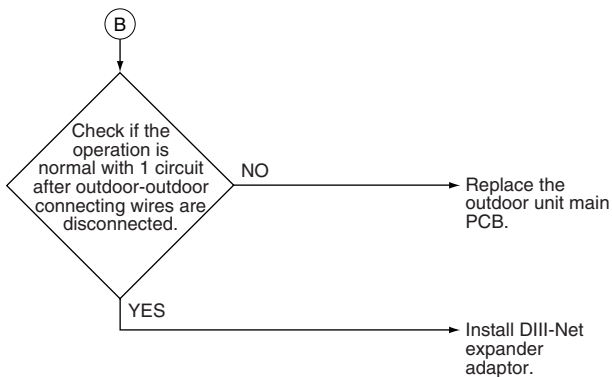

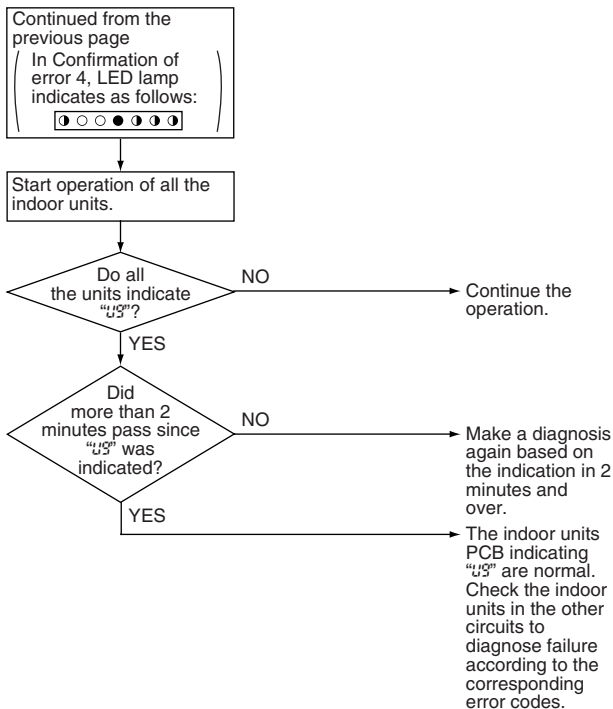

## Remote Controller Display



### Applicable Models

All indoor models

VRVII, II-S, -WII and -WIII Series

### Method of Error Detection

Micro-computer checks if transmission between indoor and outdoor (outside) units is normal.

### Error Decision Conditions

When transmission is not carried out normally for a certain amount of time

### Supposed Causes

- Indoor to outdoor, outside to outside unit transmission wiring F1, F2 disconnection, short circuit or wrong wiring
- Outdoor (outside) unit power supply is OFF
- System address does not match
- Defective indoor unit PCB
- Defective outdoor (outside) unit PCB

## Troubleshooting



### Caution

Be sure to turn off the power switch before connecting or disconnecting connectors, or parts may be damaged.

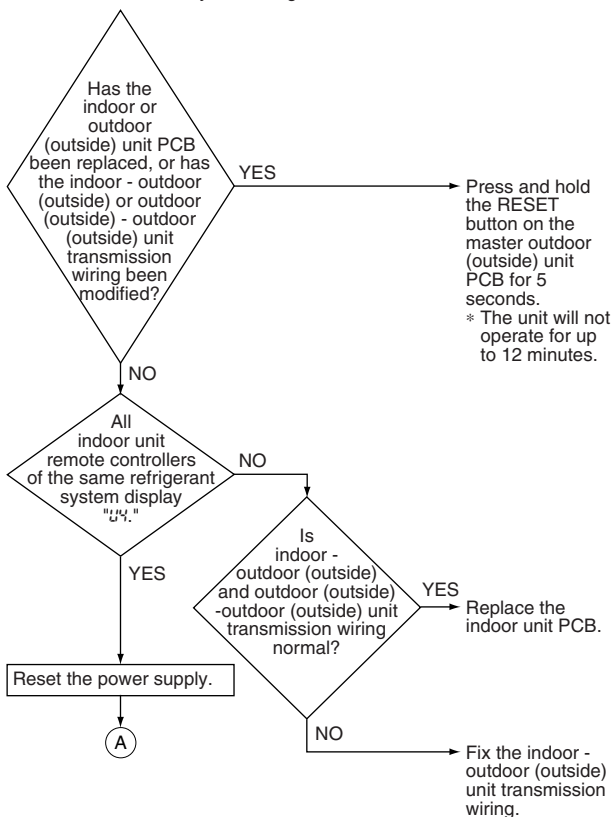

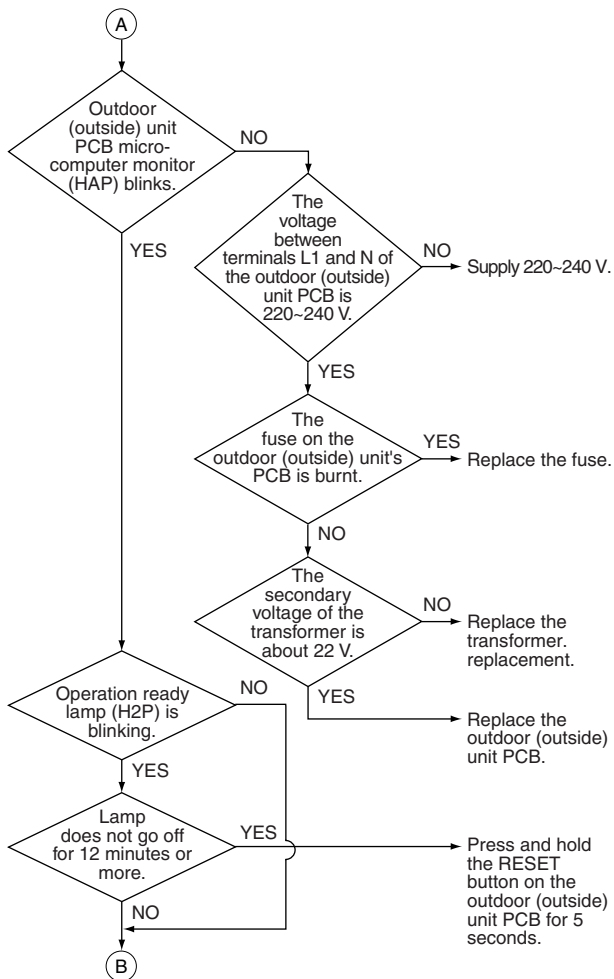

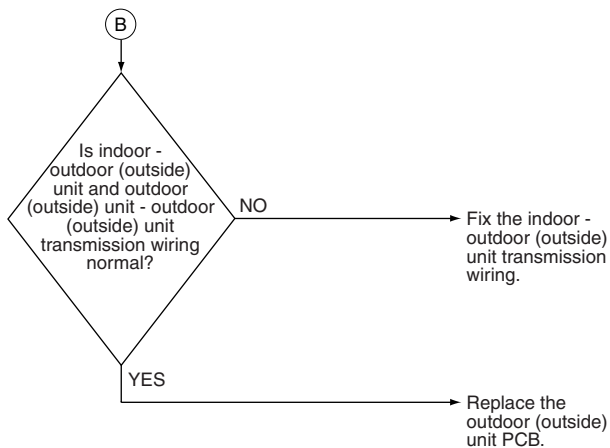

## 3.63 U5 Transmission Error between Remote Controller and Indoor Unit

### Remote Controller Display

U5

### Applicable Models

All indoor models

### Method of Error Detection

In case of controlling with 2-remote controller, check the system using micro-computer is signal transmission between indoor unit and remote controller (main and sub) is normal.

### Error Decision Conditions

Normal transmission does not continue for specified period.

### Supposed Causes

- Indoor unit and remote controller transmission error
- Connection of 2 main remote controllers (when using 2 remote controllers)
- Defective indoor unit PCB
- Defective remote controller PCB
- Defective transmission caused by noise

## Troubleshooting



### Caution

Be sure to turn off the power switch before connecting or disconnecting connectors, or parts may be damaged.

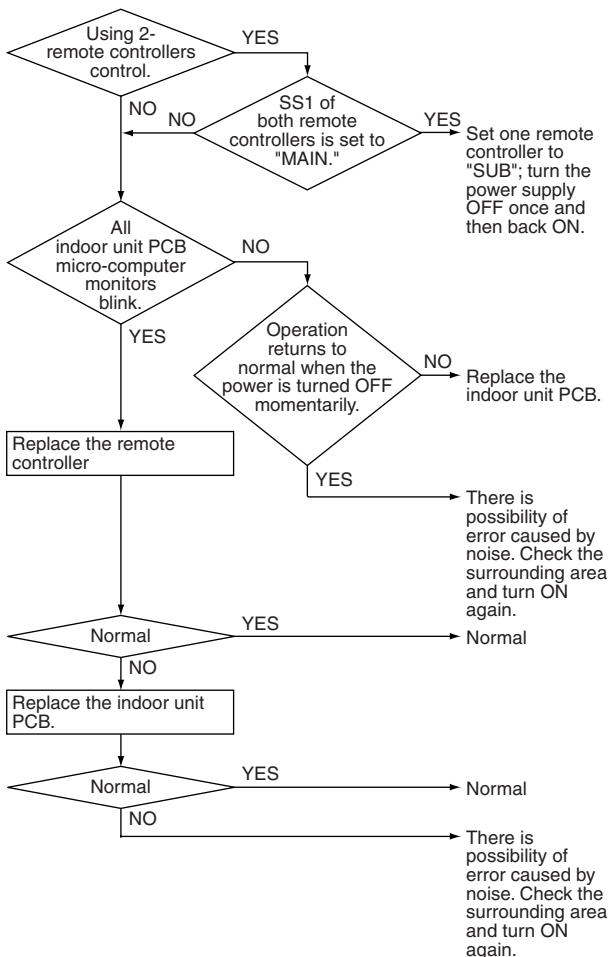



## 3.64 Transmission Error (Across Outdoor Units)

### Remote Controller Display



### Applicable Models

VRVIII and III-Q Series

### Method of Error Detection

Micro-computer checks if transmission between outdoor units is normal.

### Error Decision Conditions

When transmission is not carried out normally for a certain amount of time

### Supposed Causes

- Improper connection of transmission wiring between outdoor unit and external control adaptor for outdoor unit
- Improper connection of transmission wiring between outdoor units of multi outdoor unit connection
- Improper cool/heat selection
- Improper cool/heat unified address  
(outdoor unit, external control adaptor for outdoor unit)
- Defective outdoor unit PCB
- Defective external control adaptor for outdoor unit

## Troubleshooting



### Caution

Be sure to turn off the power switch before connecting or disconnecting connectors, or parts may be damaged.

Check the LED lamps for "Check 3" corresponding to the error code "U" and for Check 4 in the monitor mode.

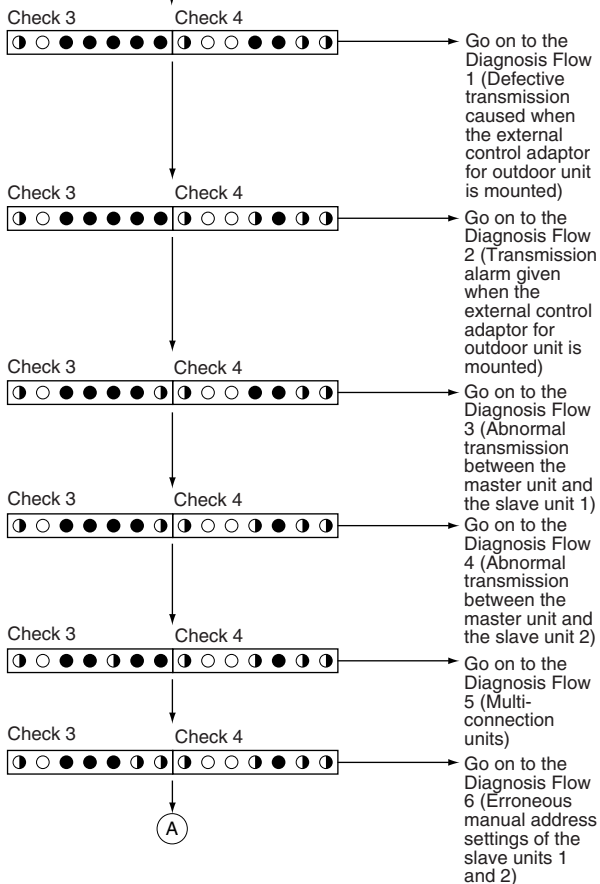

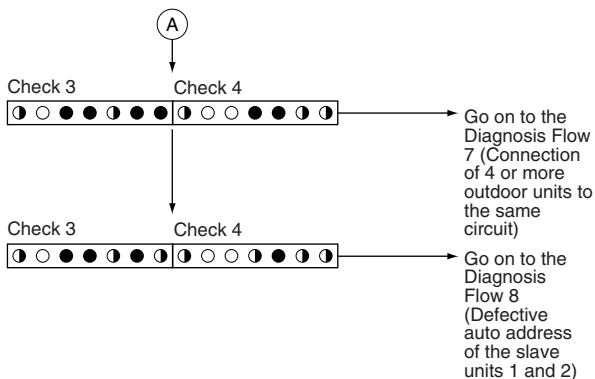

## Troubleshooting



### Caution

Be sure to turn off the power switch before connecting or disconnecting connectors, or parts may be damaged.

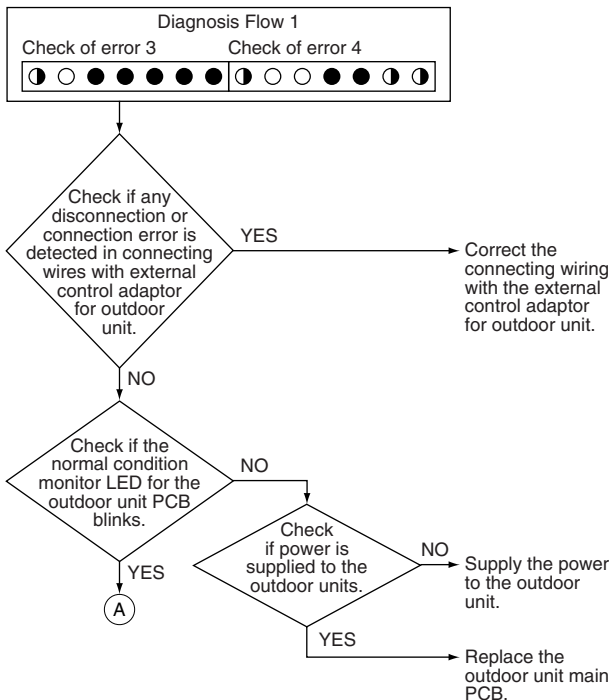

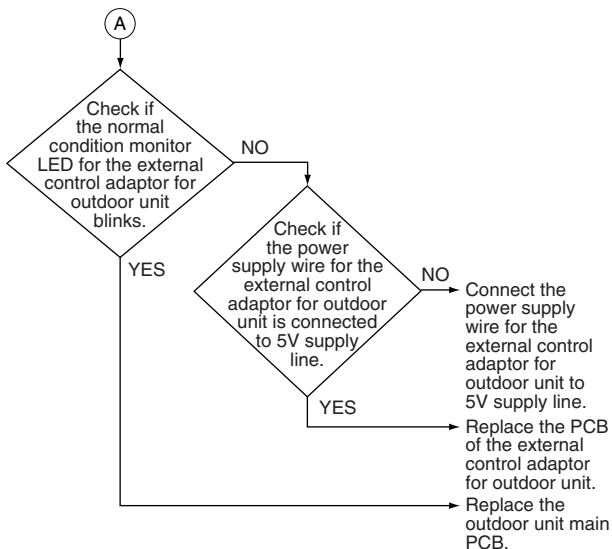

## Troubleshooting



### Caution

Be sure to turn off the power switch before connecting or disconnecting connectors, or parts may be damaged.

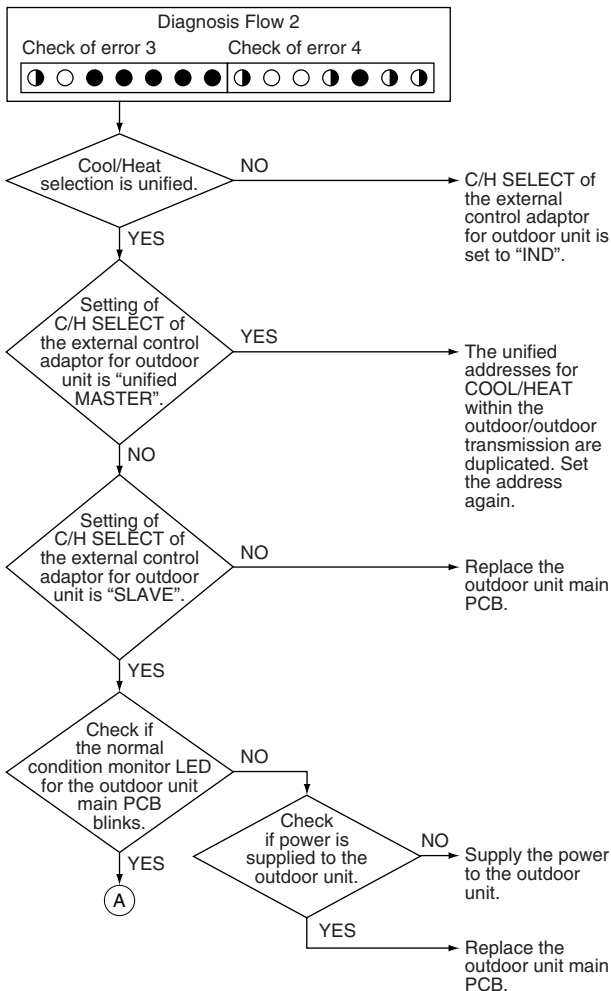

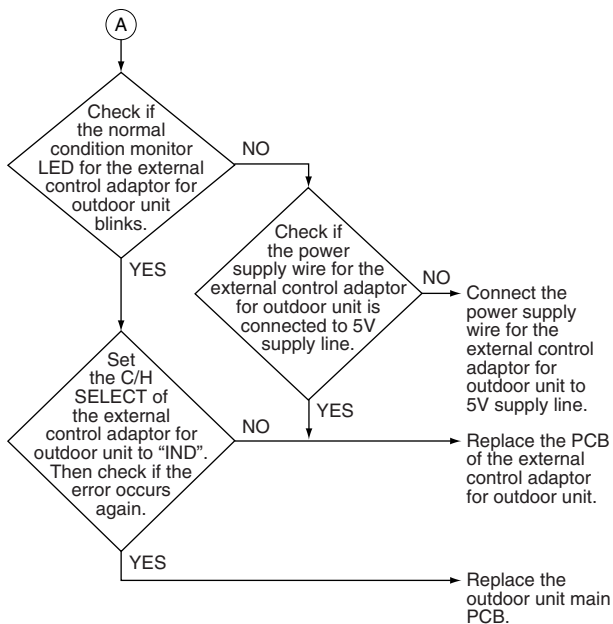

## Troubleshooting



**Caution**

Be sure to turn off the power switch before connecting or disconnecting connectors, or parts may be damaged.

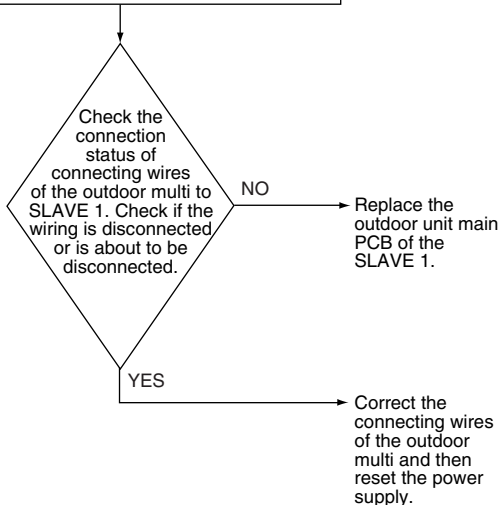
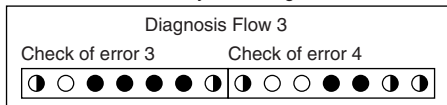



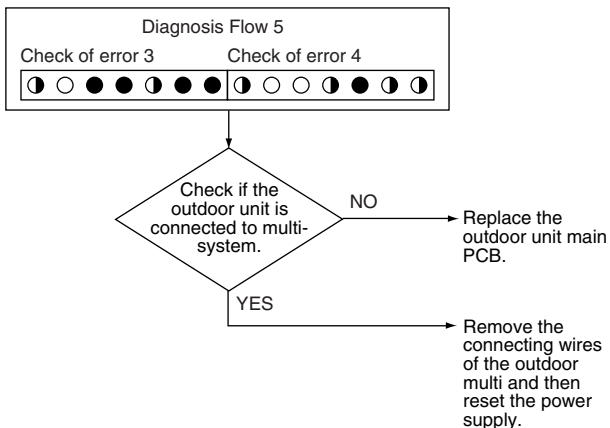
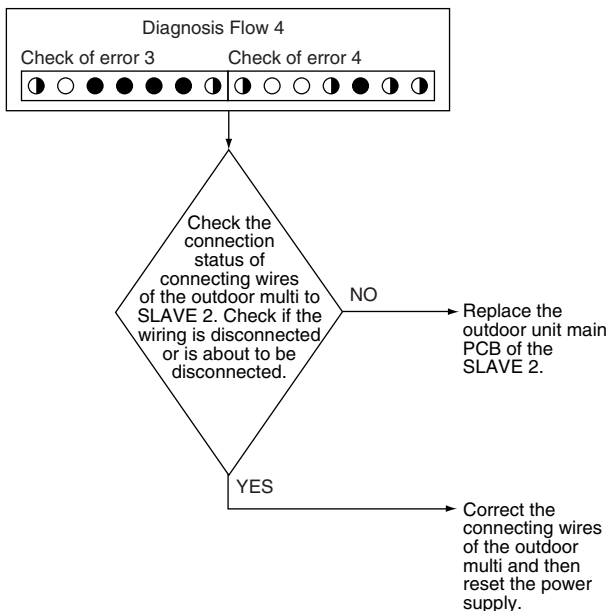

## Troubleshooting



**Caution**

Be sure to turn off the power switch before connecting or disconnecting connectors, or parts may be damaged.

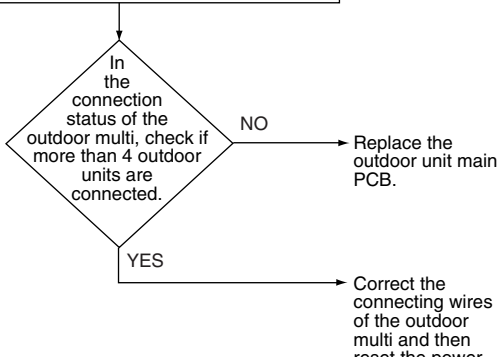
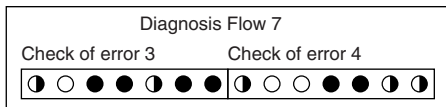
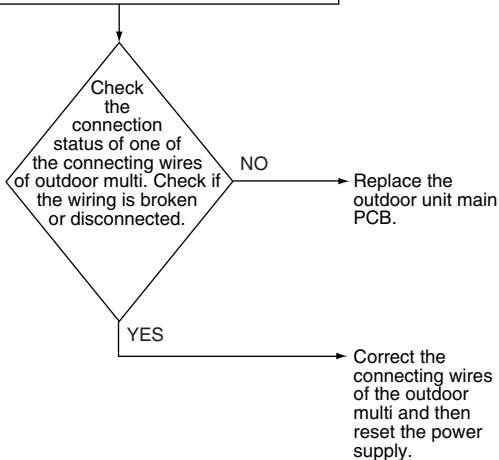
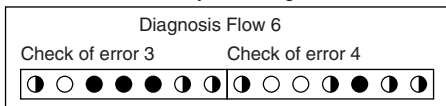

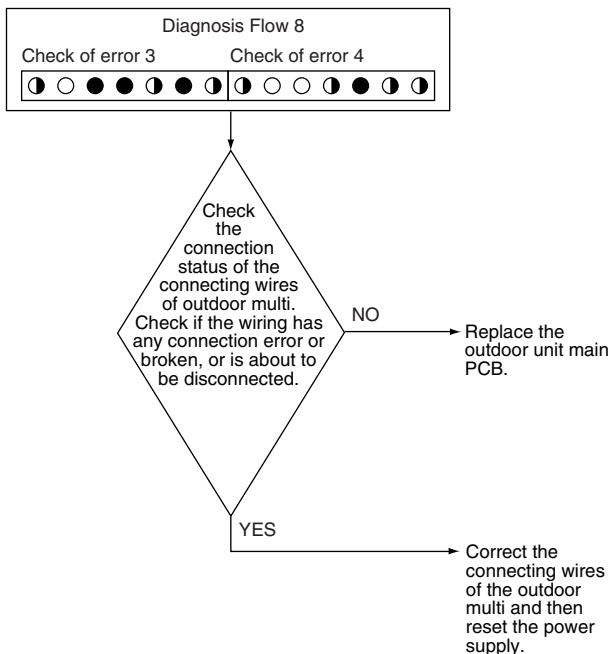

## Remote Controller Display



### Applicable Models

VRVII, -WII and -WIII Series

### Method of Error Detection

Micro-computer checks if transmission between indoor unit and remote controller is normal.

### Error Decision Conditions

When transmission is not carried out normally for a certain amount of time

### Supposed Causes

- Improper connection of transmission wiring between outdoor (outside) unit and external control adaptor for outdoor (outside) unit.
- Improper cool/heat selection
- Improper cool/heat unified address (outdoor (outside) unit, external control adaptor for outdoor (outside) unit)
- Defective outdoor (outside) unit PCB
- Defective external control adaptor for outdoor (outside) unit
- Improper connection of transmission wiring between outdoor (outside) units of multi outdoor (outside) unit connection.

## Troubleshooting



### Caution

Be sure to turn off the power switch before connecting or disconnecting connectors, or parts may be damaged.

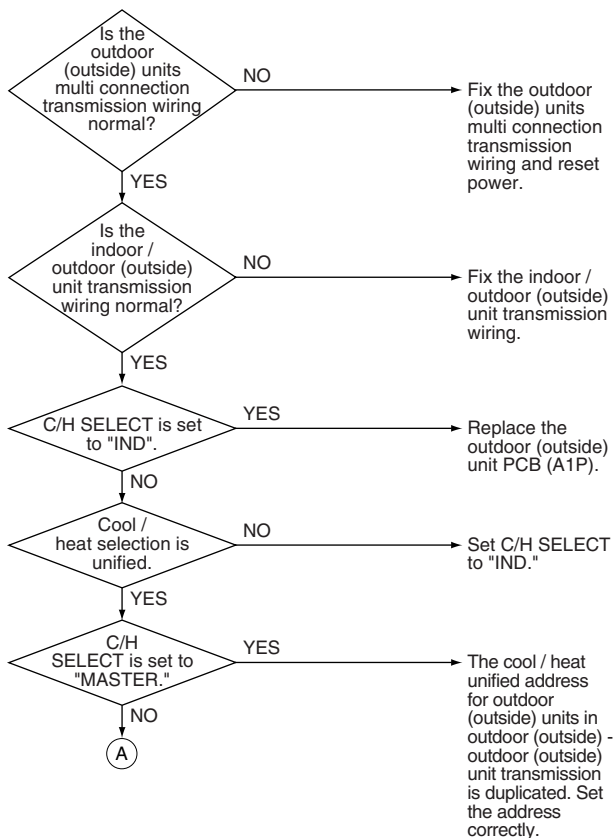

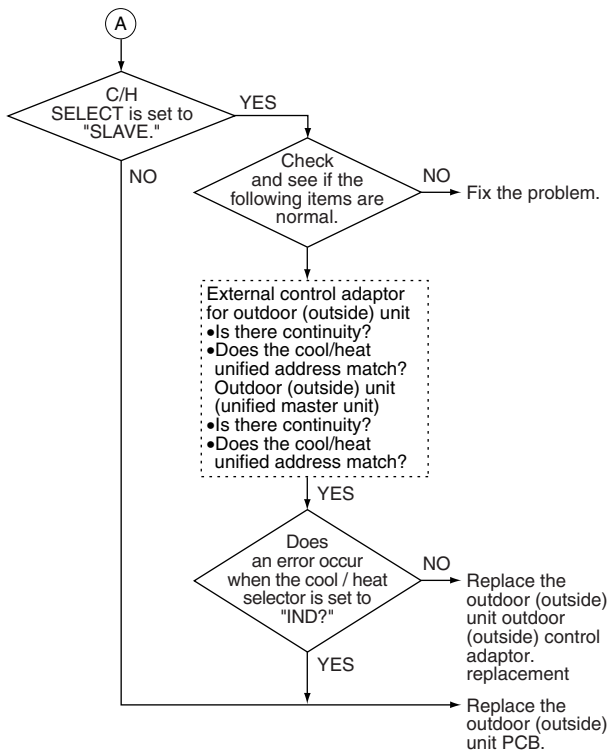

## 3.65 **U8** Transmission Error between Main and Sub Remote Controllers

### Remote Controller Display

**U8**

### Applicable Models

All indoor models

### Method of Error Detection

In case of controlling with 2-remote controller, check the system using micro-computer if signal transmission between indoor unit and remote controller (main and sub) is normal.

### Error Decision Conditions

Normal transmission does not continue for specified period.

### Supposed Causes

- Transmission error between main and sub remote controller
- Connection between sub remote controllers
- Defective remote controller PCB

## Troubleshooting



### Caution

Be sure to turn off the power switch before connecting or disconnecting connectors, or parts may be damaged.

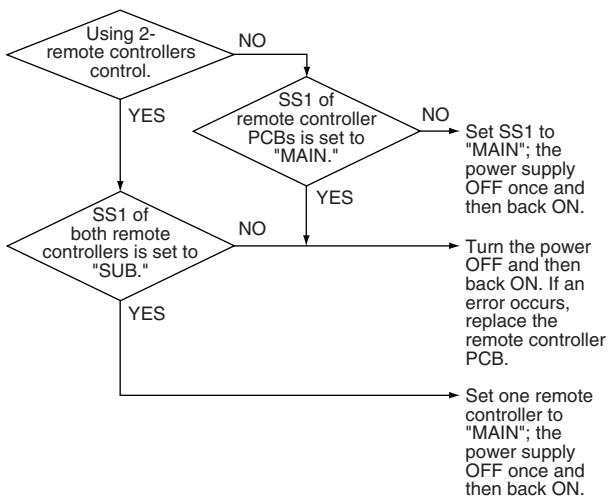



## 3.66 U9 Transmission Error between Indoor and Outdoor Units in the Same System

### Remote Controller Display

U9

### Applicable Models

All indoor models  
VRVIII, III-S and III-Q Series

### Method of Error Detection

Detect the abnormal signal for the other indoor units  
within the circuit by outdoor unit PCB

### Error Decision Conditions

When the error decision is made on any other indoor unit  
within the system concerned

### Supposed Causes

- Transmission error within or outdoor of other system
- Defective electronic expansion valve in indoor unit of other system
- Defective PCB of indoor unit in other system
- Improper connection of transmission wiring between indoor and outdoor unit

## Troubleshooting



### Caution

Be sure to turn off the power switch before connecting or disconnecting connectors, or parts may be damaged.

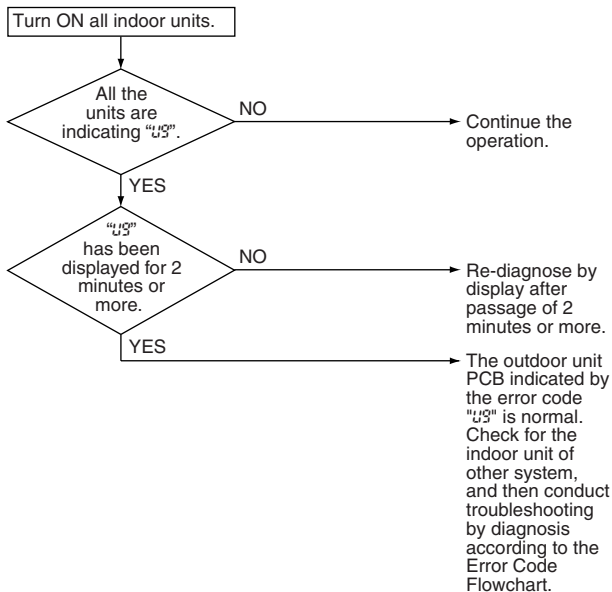

## Remote Controller Display

U9

### Applicable Models

All indoor models

VRVII, II-S, -WII and -WIII Series

### Method of Error Detection

Detect the abnormal signal of any other indoor unit within the system concerned.

### Error Decision Conditions

When the error decision is made on any other indoor unit within the system concerned.

### Supposed Causes

- Transmission error within or outdoor (outside) of other system
- Error of electronic expansion valve in indoor unit of other system
- Defective PCB of indoor unit in other system
- Improper connection of transmission wiring between indoor and outdoor (outside) unit

## Troubleshooting



### Caution

Be sure to turn off the power switch before connecting or disconnecting connectors, or parts may be damaged.

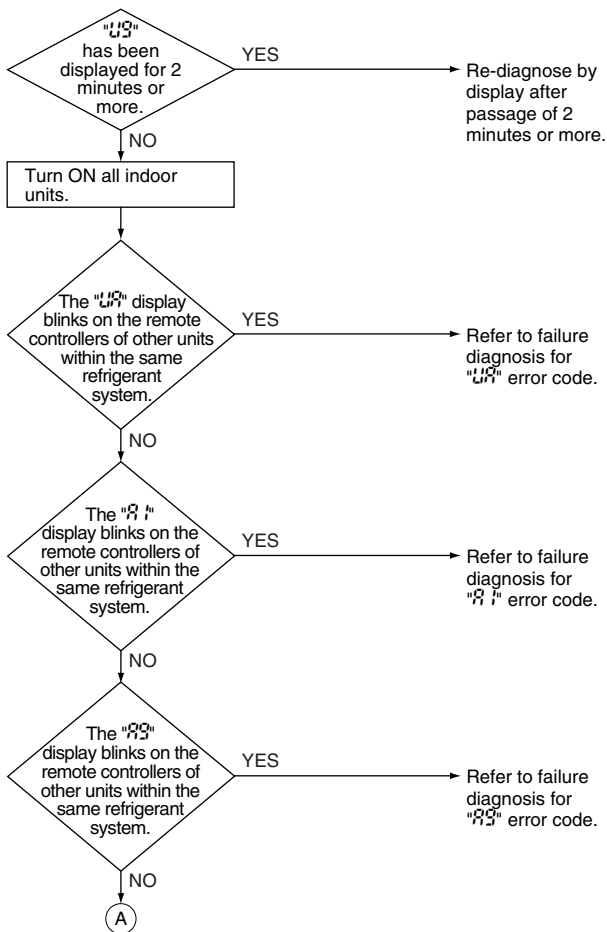

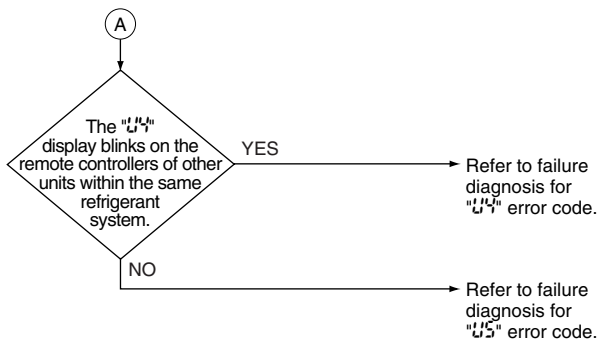

## 3.67 **UR** Improper Combination of Indoor and Outdoor Units, Indoor Units and Remote Controller

### Remote Controller Display



### Applicable Models

All indoor models  
VRVIII and III-Q Series

### Method of Error Detection

A difference occurs in data by the type of refrigerant between indoor and outdoor units.

The number of indoor units is out of the allowable range.

### Error Decision Conditions

The error decision is made as soon as either of the abnormalities aforementioned is detected.

### Supposed Causes

- Excess of connected indoor units
- Defective outdoor unit PCB
- Mismatching of the refrigerant type of indoor and outdoor unit.
- Setting of outdoor unit PCB was not conducted after replacing to spare PCB.

## Troubleshooting



### Caution

Be sure to turn off the power switch before connecting or disconnecting connectors, or parts may be damaged.

Check the LED lamps for "Check 3" corresponding to the error code "U1" and for Check 4 in the monitor mode.

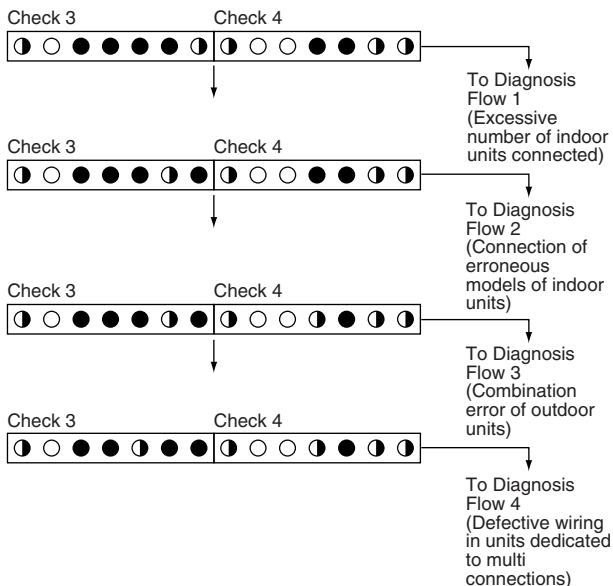

## Troubleshooting



### Caution

Be sure to turn off the power switch before connecting or disconnecting connectors, or parts may be damaged.

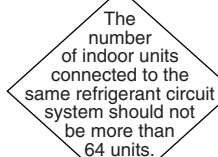
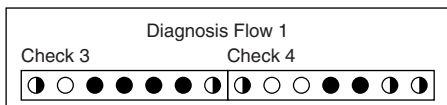

YES

Replace the outdoor unit main PCB.

NO

The number of indoor units exceeds the standard. Check the connection to correct.

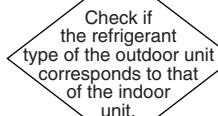
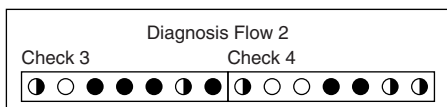

YES

Replace the outdoor unit main PCB.

NO

Match the refrigerant types of the outdoor unit and the indoor unit.



## Troubleshooting



### Caution

Be sure to turn off the power switch before connecting or disconnecting connectors, or parts may be damaged.

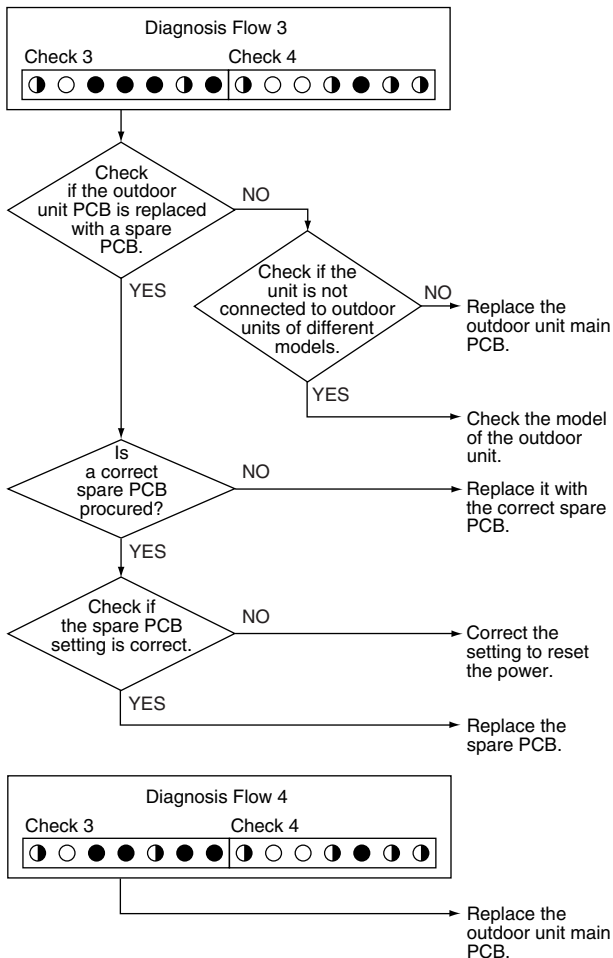

## Remote Controller Display



### Applicable Models

All indoor models

VRVIII-S Series

### Method of Error Detection

A difference occurs in data by the type of refrigerant between indoor and outdoor units.

The number of indoor units is out of the allowable range. Incorrect signals are transmitted among the indoor unit, BS unit, and outdoor unit.

### Error Decision Conditions

The error decision is made as soon as either of the abnormalities aforementioned is detected.

### Supposed Causes

- Excess of connected indoor units
- Defective outdoor unit PCB
- Mismatching of the refrigerant type of indoor and outdoor unit.
- Setting of outdoor unit PCB was not conducted after replacing to spare PCB.
- The outdoor unit PCB was replaced with wrong one.

## Troubleshooting



### Caution

Be sure to turn off the power switch before connecting or disconnecting connectors, or parts may be damaged.

Check the LED lamps for "Check 3" corresponding to the error code "U7" and for Check 4 in the monitor mode.

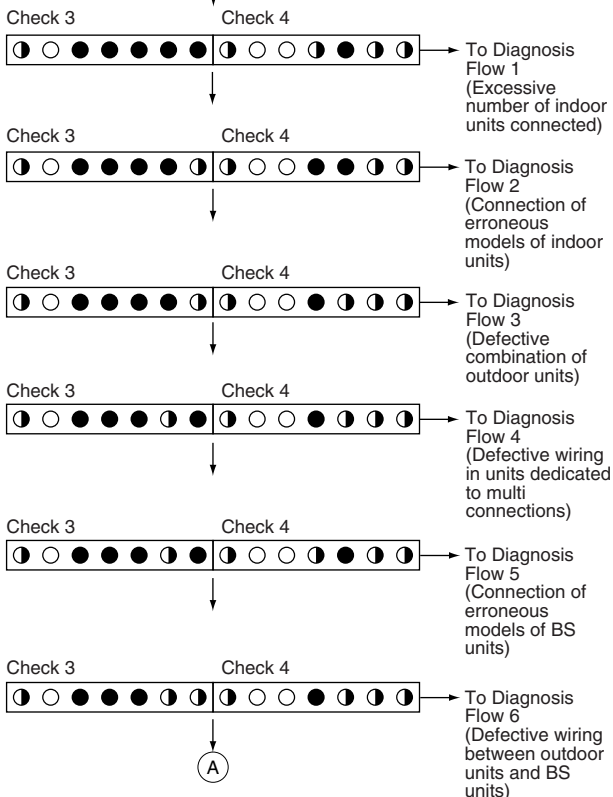

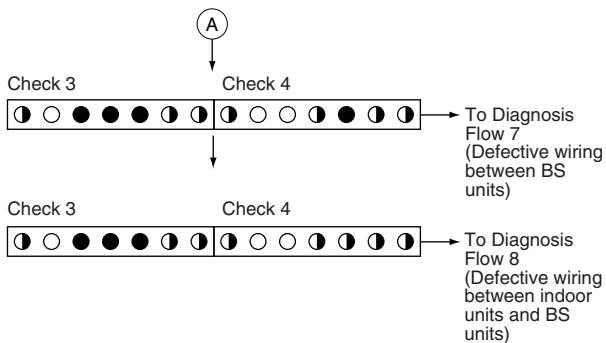

## Troubleshooting



### Caution

Be sure to turn off the power switch before connecting or disconnecting connectors, or parts may be damaged.

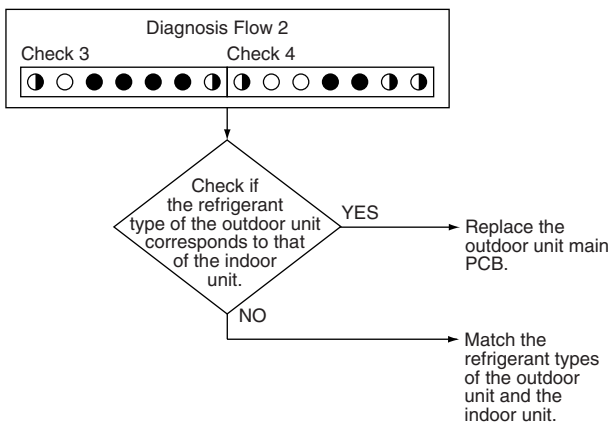
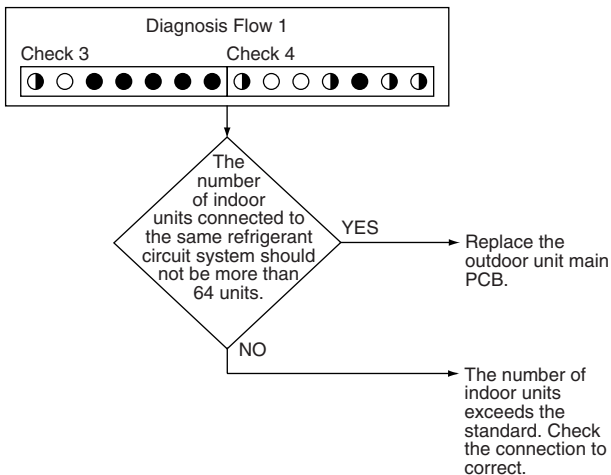

## Troubleshooting



### Caution

Be sure to turn off the power switch before connecting or disconnecting connectors, or parts may be damaged.

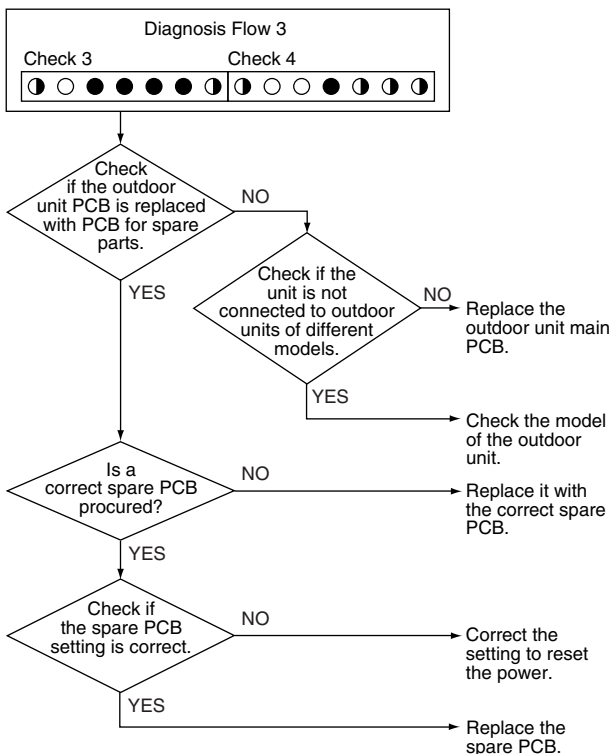

## Troubleshooting



### Caution

Be sure to turn off the power switch before connecting or disconnecting connectors, or parts may be damaged.

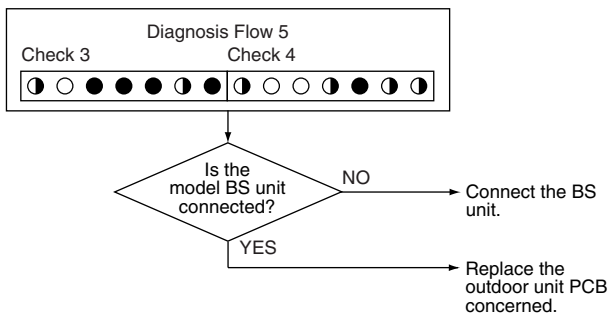
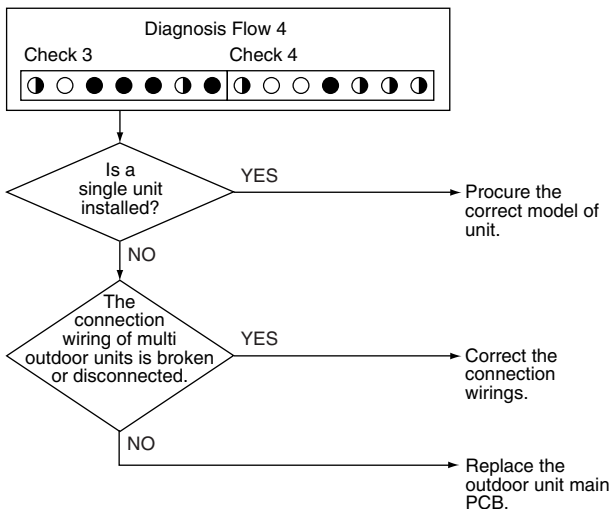

## Troubleshooting



**Caution**

Be sure to turn off the power switch before connecting or disconnecting connectors, or parts may be damaged.

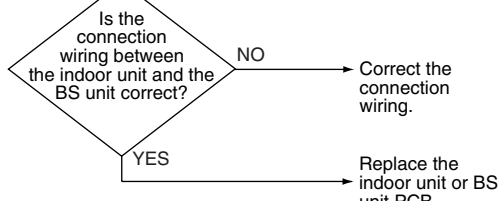
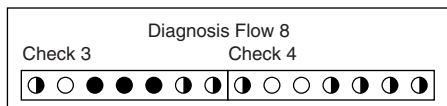
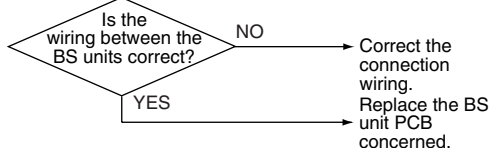
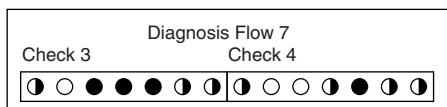
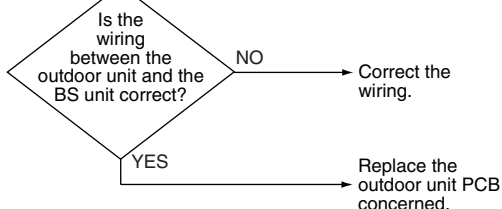
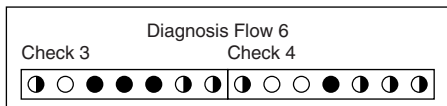



## Remote Controller Display



### Applicable Models

All indoor models

VRVII, II-S, -WII and -WIII Series

### Method of Error Detection

Detect abnormalities in combination of indoor and outdoor (outside) units and the remote controller using the outdoor (outside) unit PCB.

### Error Decision Conditions

When any of the followings is detected, failure is instantly confirmed.

- When there is a problem in the combination of the indoor and outdoor (outside) units
- When there is a problem in the combination of the indoor unit and the remote controller

### Supposed Causes

- Excess of connected indoor units
- Defective outdoor (outside) unit PCB
- Mismatching of the refrigerant type of indoor and outdoor (outside) unit.
- Setting of outdoor (outside) unit PCB was not conducted after replacing to spare PCB.

## Troubleshooting



### Caution

Be sure to turn off the power switch before connecting or disconnecting connectors, or parts may be damaged.

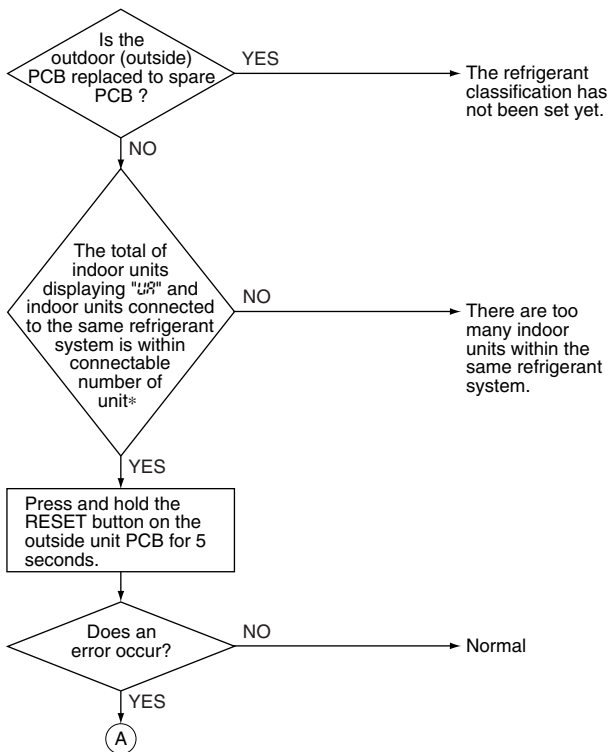

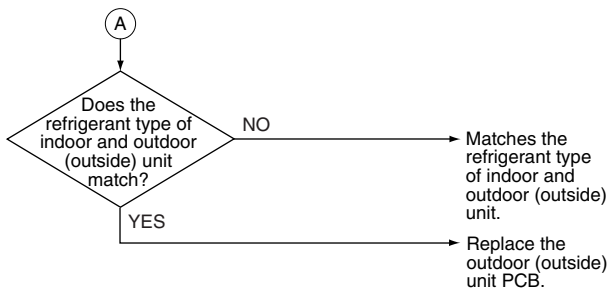

**Note:**

\* The number of indoor units that can be connected to a single outside unit system depends on the type of outside unit.

## 3.68 Address Duplication of Centralized Remote Controller

### Remote Controller Display



### Applicable Models

- All indoor models
- Centralized remote controller

### Method of Error Detection

The principal indoor unit detects the same address as that of its own on any other indoor unit.

### Error Decision Conditions

The error decision is made as soon as the abnormality aforementioned is detected.

### Supposed Causes

- Address duplication of centralized remote controller
- Defective indoor unit PCB

### Troubleshooting



**Caution**

Be sure to turn off the power switch before connecting or disconnecting connectors, or parts may be damaged.

The centralized address is duplicated.

→ Make setting change so that the centralized address will not be duplicated.

## 3.69 **UE** Transmission Error between Centralized Remote Controller and Indoor Unit

### Remote Controller Display



### Applicable Models

All indoor models      intelligent Touch Controller  
Centralized remote controller  
Schedule timer

### Method of Error Detection

Micro-computer checks if transmission between indoor unit and centralized remote controller is normal.

### Error Decision Conditions

When transmission is not carried out normally for a certain amount of time

### Supposed Causes

- Transmission error between optional controllers for centralized control and indoor unit
- Connector for setting main controller is disconnected. (or disconnection of connector for independent / combined use changeover switch.)
- Defective PCB for centralized remote controller
- Defective indoor unit PCB

## Troubleshooting



### Caution

Be sure to turn off the power switch before connecting or disconnecting connectors, or parts may be damaged.

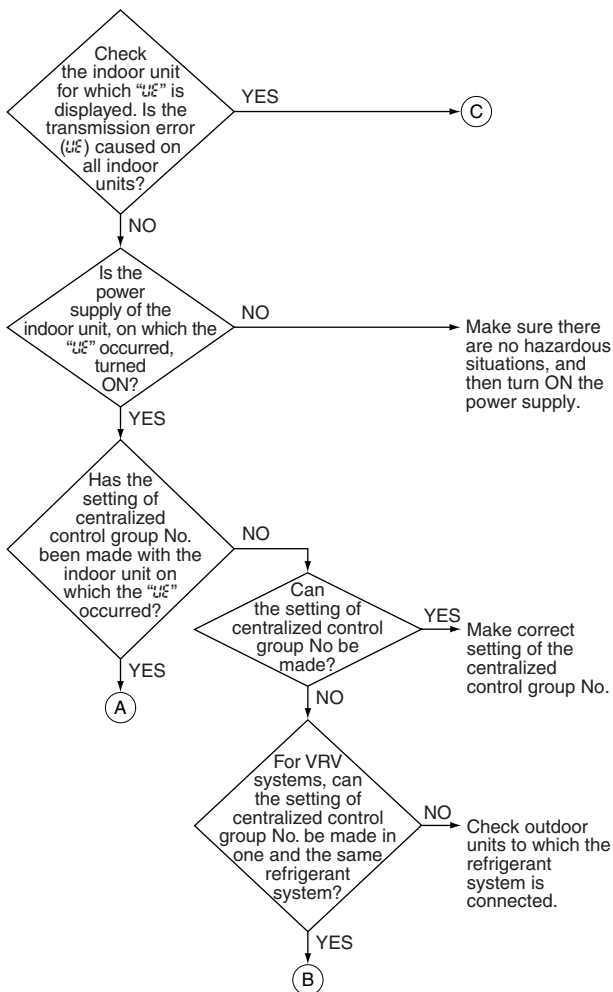

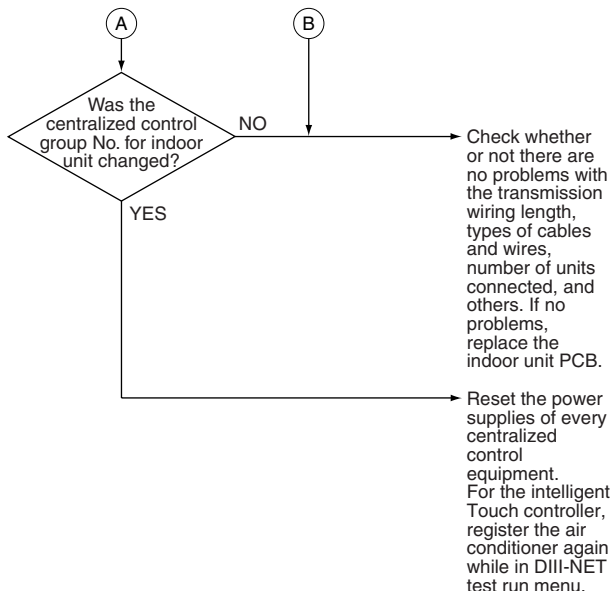

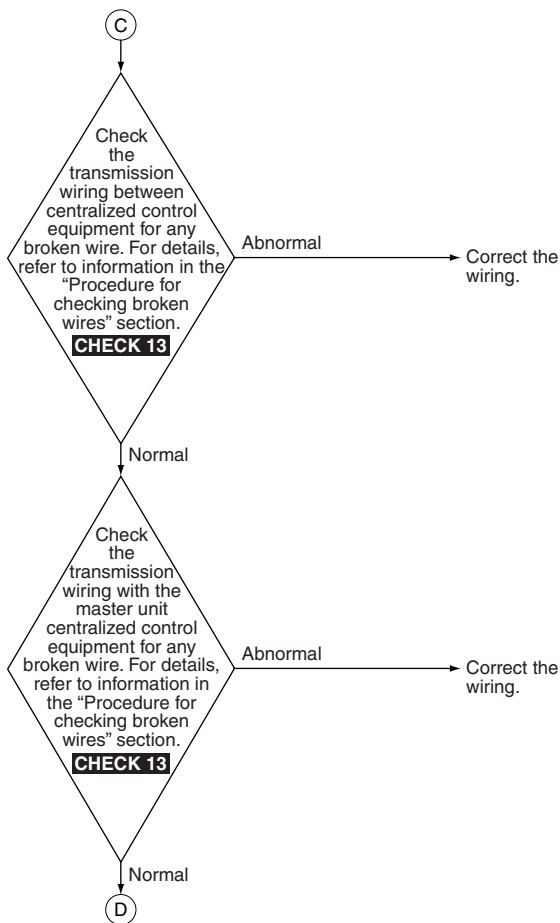



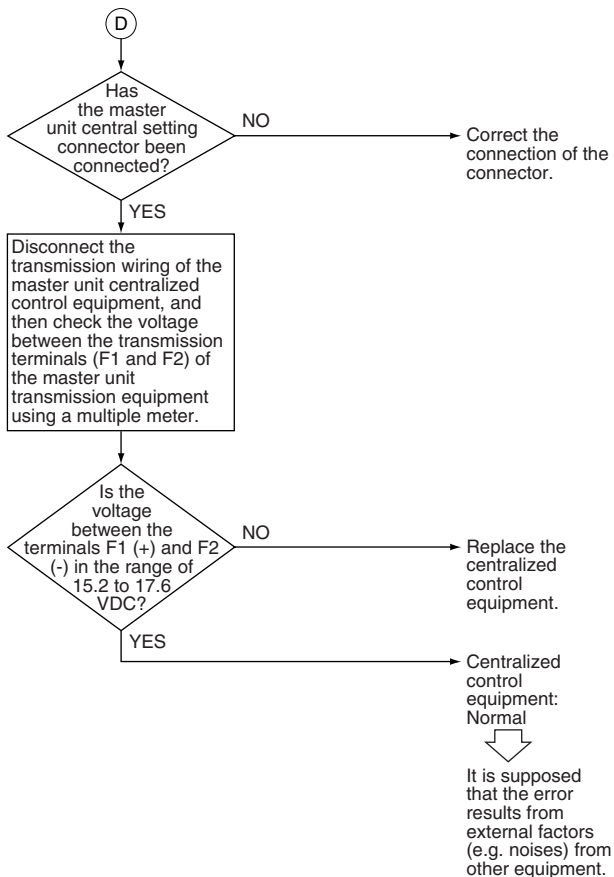

**CHECK 13** Refer to P.373.

## 3.70 System is not Set yet

### Remote Controller Display



### Applicable Models

All indoor models

All outdoor unit series

### Method of Error Detection

On check operation, the number of indoor units in terms of transmission is not corresponding to that of indoor units that have made changes in temperature.

### Error Decision Conditions

The error is determined as soon as the abnormality aforementioned is detected through checking the system for any erroneous connection of units on the check operation.

### Supposed Causes

- Improper connection of transmission wiring between indoor-outdoor units and outdoor-outdoor units
- Failure to execute check operation
- Defective indoor unit PCB
- Stop valve is not opened.

## Troubleshooting



### Caution

Be sure to turn off the power switch before connecting or disconnecting connectors, or parts may be damaged.

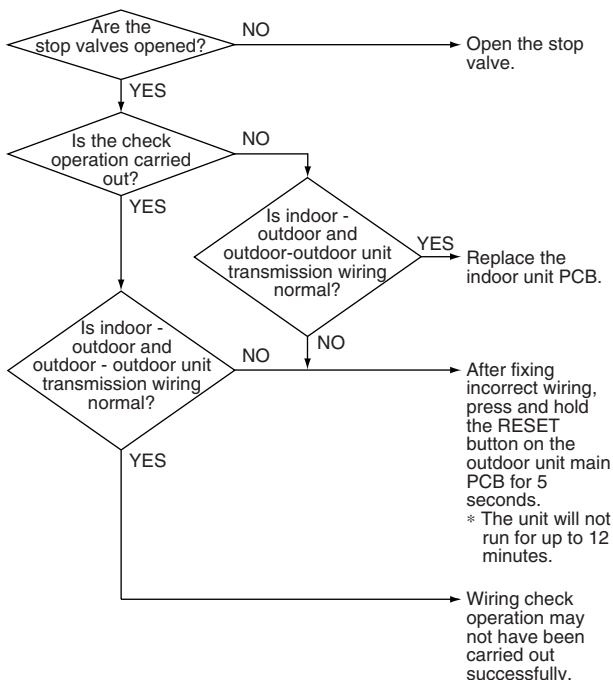

### Note:

Wiring check operation may not be successful if carried out after the outdoor unit has been OFF for more than 12 hours, or if it is not carried out after running all connected indoor units in the fan mode for at least an hour.

## 3.71 System Abnormality, Refrigerant System Address Undefined

### Remote Controller Display



### Applicable Models

- All indoor models
- All outdoor unit series

### Method of Error Detection

Detect an indoor unit with no address setting.

### Error Decision Conditions

The error decision is made as soon as the abnormality aforementioned is detected.

### Supposed Causes

- Improper connection of transmission wiring between indoor-outdoor units and outdoor-outdoor units
- Defective indoor unit PCB
- Defective outdoor unit main PCB

## Troubleshooting



### Caution

Be sure to turn off the power switch before connecting or disconnecting connectors, or parts may be damaged.

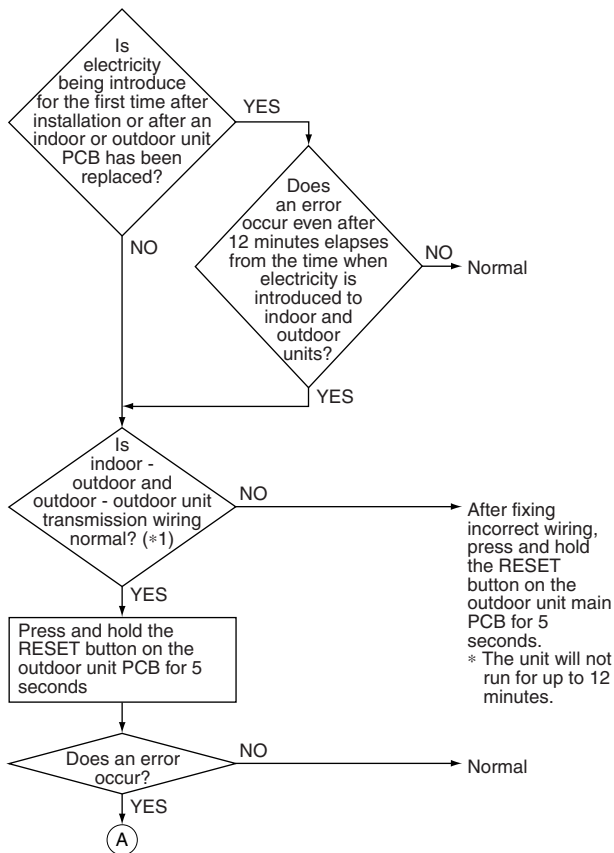

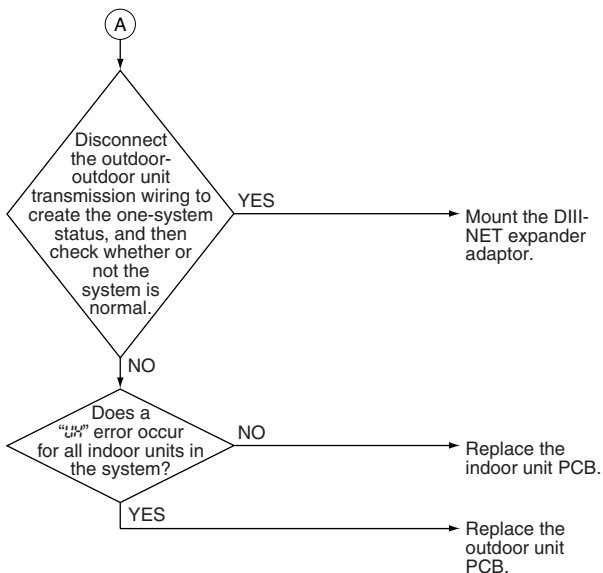

## Note:

- \*1. Check the correct wiring “indoor-outdoor” and “outdoor-outdoor” by Installation manual.
- \*2. What is Auto Address?  
This is the address automatically assigned to indoor units and outdoor units after initial power supply upon installation, or after executing rewiring (Keep pressing the **RESET** button for more than 4 seconds).

## CHECK 1 Check for causes of rise in high pressure

Referring to the Fault Tree Analysis (FTA) shown below, probe the defective points.

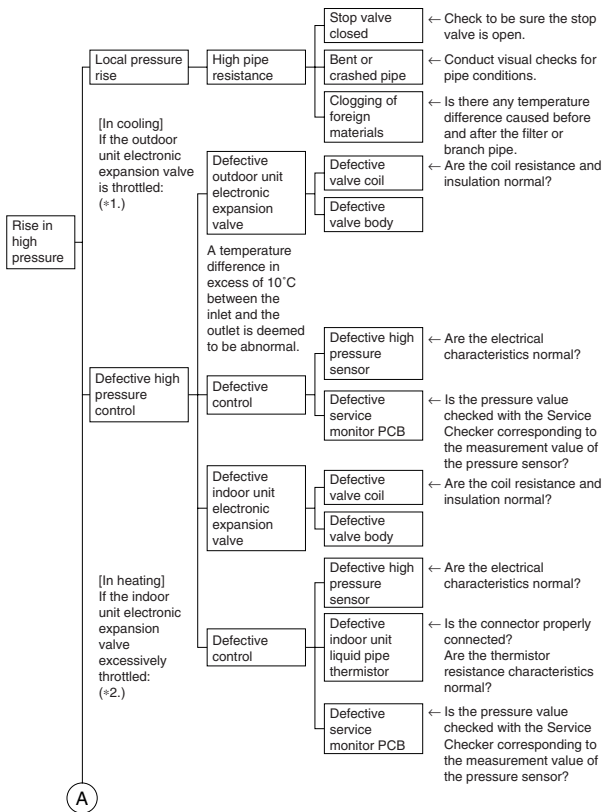

A

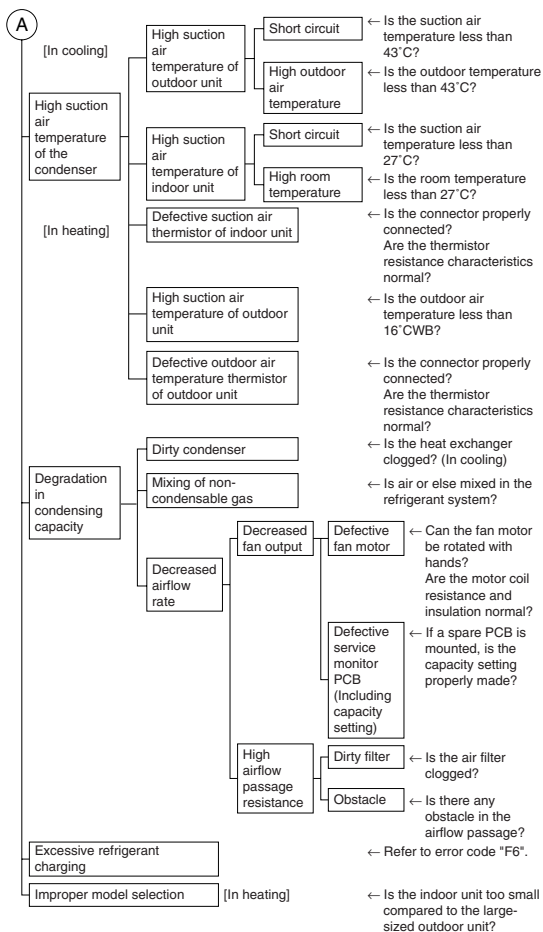

**i Note:**

- \*1. In cooling, it is normal if the outdoor unit electronic expansion valve (EVM) is fully open.
- \*2. In heating, the indoor unit electronic expansion valve



## CHECK 2 Check for causes of drop in low pressure

Referring to the Fault Tree Analysis (FTA) shown below, probe the defective points.

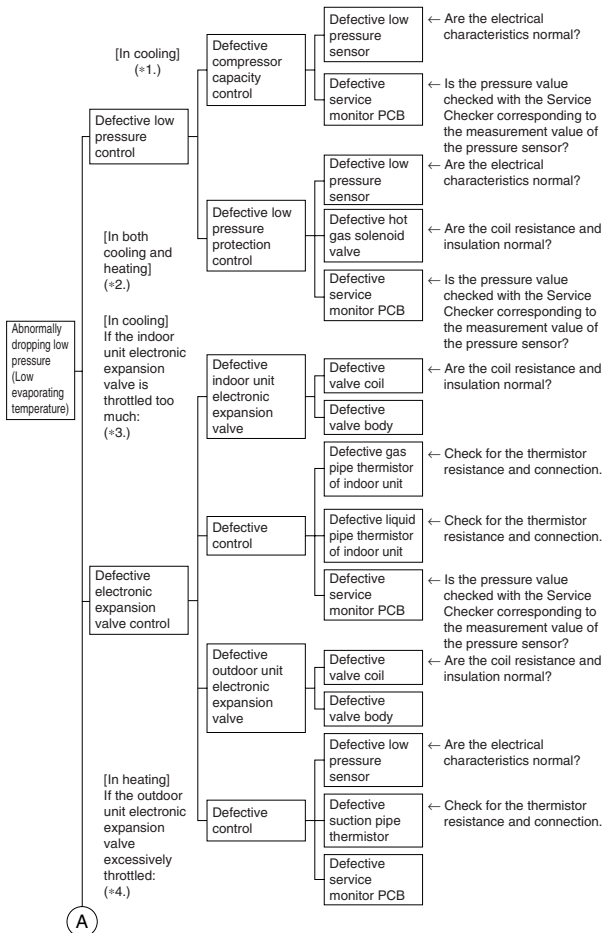

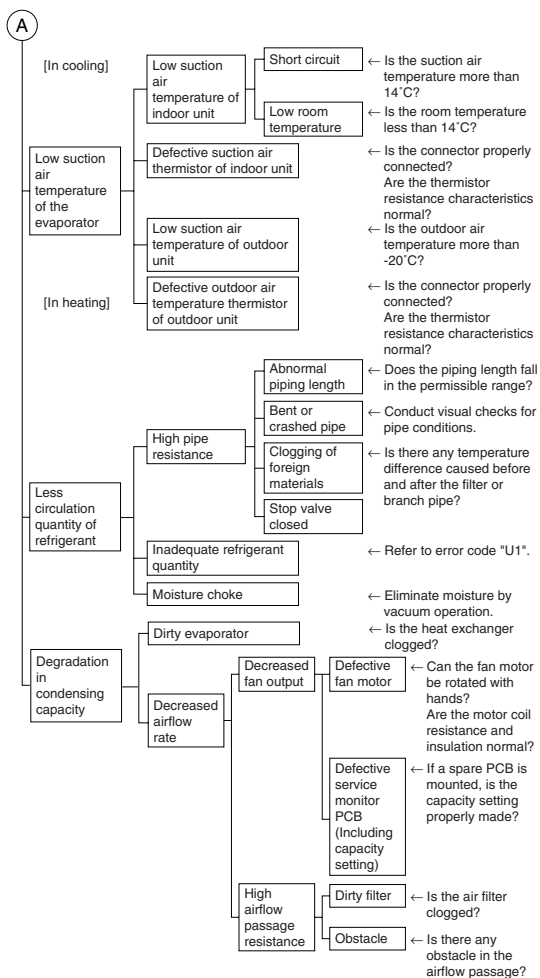



**Note:**

- \*1. For details of compressor capacity control while in cooling, refer to “Compressor PI control”.
- \*2. The “low pressure protection control” includes low pressure protection control and hot gas bypass control.
- \*3. In cooling, the indoor unit electronic expansion valve is used for “superheated degree control”.
- \*4. In heating, the outdoor unit electronic expansion valve (EVM) is used for “superheated degree control of outdoor unit heat exchanger”.

### CHECK 3 Check the Factors of Overheat

#### Operation

Referring to the Fault Tree Analysis (FTA) shown below, probe the defective points.

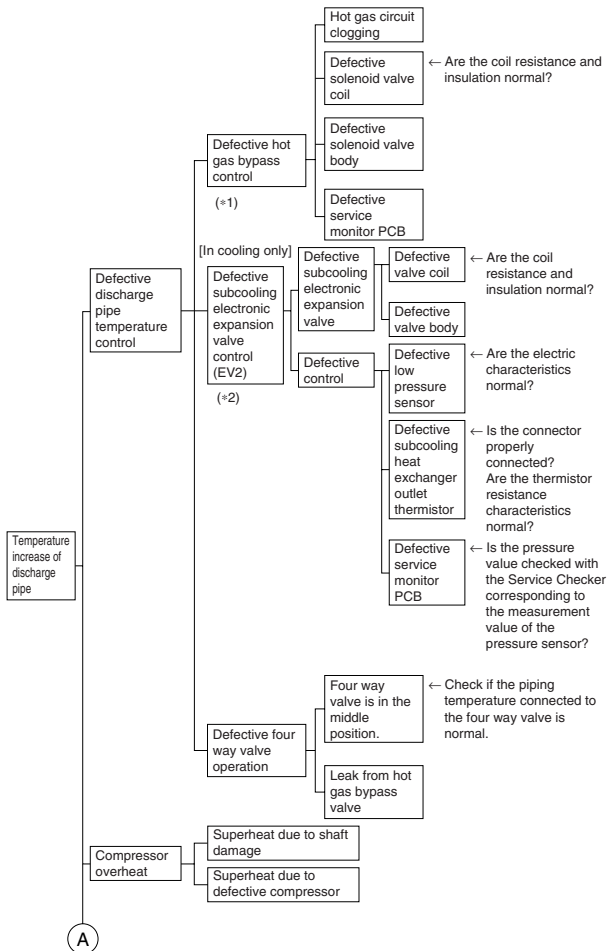





**Note:**

- \*1. Refer to “Low pressure protection control” for hot gas bypass control.
- \*2. Refer to “Subcooling electronic expansion valve control”.
- \*3. “Superheating temperature control” in cooling is conducted by indoor unit electronic expansion valve.
- \*4. Superheating temperature control in heating is conducted by outdoor unit electronic expansion valve (EVM).
- \*5. Judgement criteria of superheat operation:
  - ① Suction gas superheated degree: 10°C and over.
  - ② Discharge gas superheated degree: 45°C and over, except immediately after compressor starts up or is running under drooping control.(Use the above values as a guide. Depending on the other conditions, the unit may be normal despite the values within the above range.)

## CHECK 4 Power Transistor Check

Perform the following procedures prior to check.

- (1) Power OFF.
- (2) Remove all the wiring connected to the PCB where power transistors are mounted on.

### [Preparation]

- Multiple tester

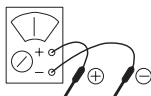

- \* Prepare the analog type of multiple tester. For the digital type of multiple tester, those with diode check function are available for the checking.

### [Point of Measurement and Judgement Criteria]

- Turn OFF the power supply. Then, after a lapse of 10 minutes or more, make measurement of resistance.

When using the analog type of multiple tester, make measurement in resistance measurement mode in the  $\times 1k\Omega$  range.

No.	Measuring point		Judgement Criteria	Remarks
	+	-		
1	P2	U	2 ~ 15k $\Omega$	Due to condenser charge and so on, resistance measurement may require some time.
2	P2	V		
3	P2	W		
4	U	P2	15k $\Omega$ and more (including $\infty$ )	
5	V	P2		
6	W	P2		
7	N3	U		
8	N3	V		
9	N3	W	2 ~ 15k $\Omega$	
10	U	N3		
11	V	N3		
12	W	N3		

When using the digital type of multiple tester, make measurement in diode check mode (→|←)

No.	Measuring point		Judgement Criteria	Remarks
	+	-		
1	P2	U	1.2V and more	Due to condenser charge and so on, resistance measurement may require some time.
2	P2	V		
3	P2	W		
4	U	P2	0.3 ~ 0.7V	
5	V	P2		
6	W	P2		
7	N3	U		
8	N3	V		
9	N3	W		
10	U	N3	1.2V and more	Due to condenser charge and so on, resistance measurement may require some time.
11	V	N3		
12	W	N3		



[PCB and Circuit Diagram]

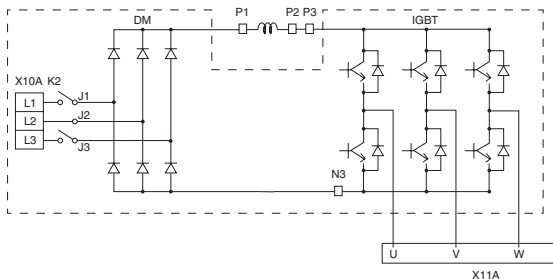
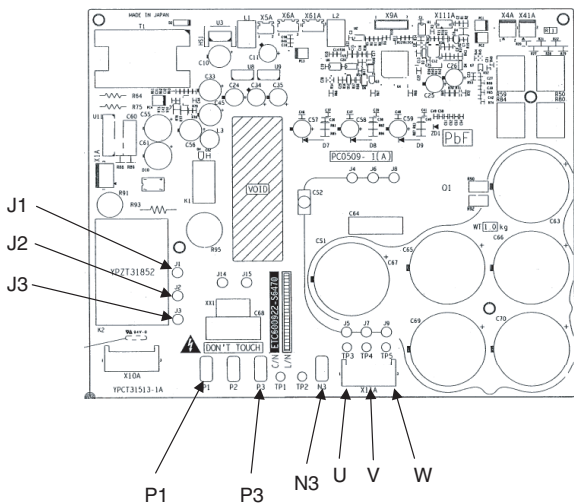

## CHECK 5 Check for causes of wet operation.

Referring to the Fault Tree Analysis (FTA) shown below, probe the defective points.

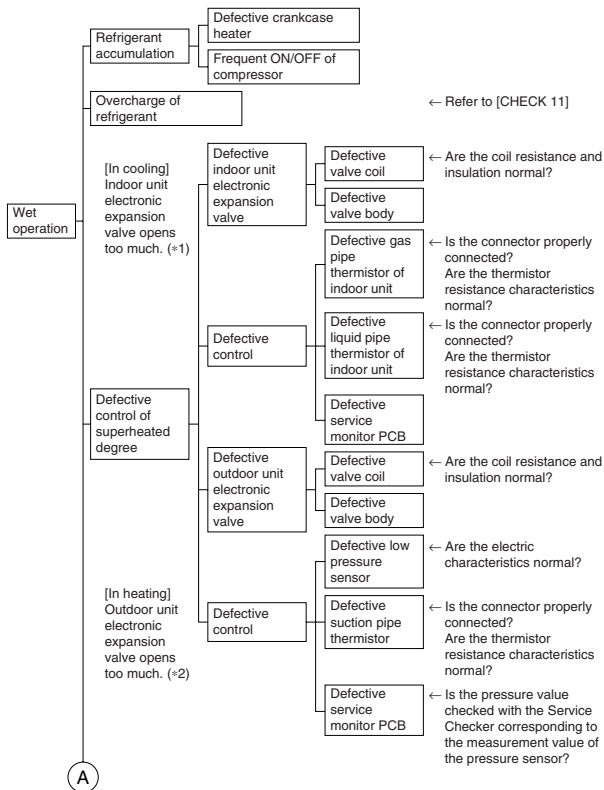

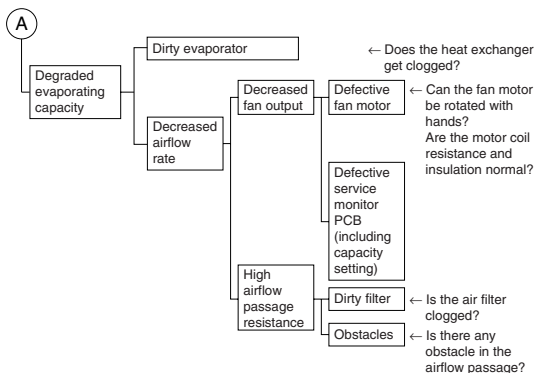

## **i** Note:

- \*1. “Superheating temperature control” in cooling is conducted by indoor unit electronic expansion valve.
- \*2. Superheating temperature control in heating is conducted by outdoor unit electronic expansion valve (EVM).
- \*3. Guideline of superheated degree to judge as wet operation
  - ① Suction gas superheated degree: Not more than 3°C;
  - ② Discharge gas superheated degree: Not more than 15°C, except immediately after compressor starts up or is running under drooping control.
 (Use the above values as a guide. Depending on the other conditions, the unit may be normal despite the values within the above range.)

## CHECK 6 Check for overcharge of refrigerant.

In case of VRV Systems, the only way to judge as the overcharge of refrigerant is with operating conditions due to the relationship to pressure control and electronic expansion valve control.

As information for making a judgement, refer to the information below.

### Diagnosis of overcharge of refrigerant

1. High pressure rises. Consequently, overload control is conducted to cause insufficient cooling capacity.
2. The superheated degree of suction gas lowers (or the wet operation is performed).

Consequently, the compressor becomes lower in discharge pipe temperature despite of pressure loads.

3. The subcooling degree of condensate rises.

Consequently, in heating, the temperature of discharge air through the subcooling section becomes lower.

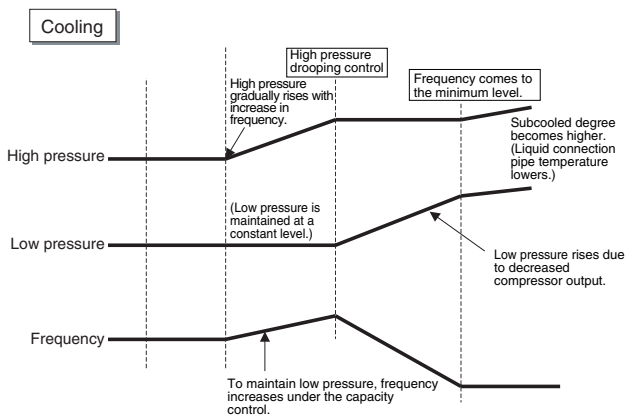

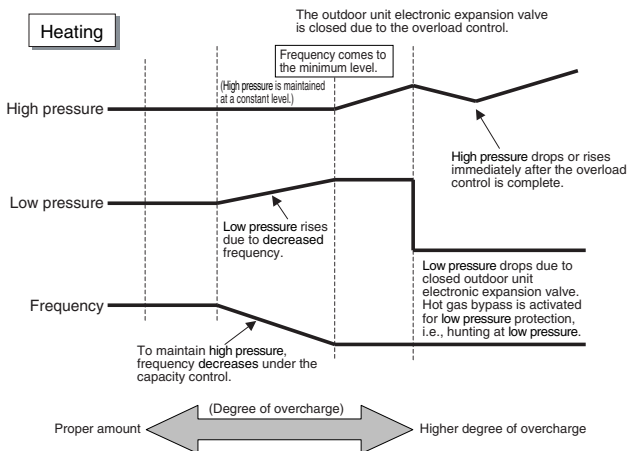

## CHECK 7 Check for shortage of refrigerant.

In case of VRV Systems, the only way to judge as the shortage of refrigerant is with operating conditions due to the relationship to pressure control and electronic expansion valve control.

As information for making a judgement, refer to the information below.

### Diagnosis of shortage of refrigerant

1. The superheated degree of suction gas rises.  
Consequently, the compressor discharge gas temperature becomes higher.
2. The superheated degree of suction gas rises.  
Consequently, the electronic expansion valve turns open.
3. Low pressure drops to cause the unit not to demonstrate cooling capacity (heating capacity).

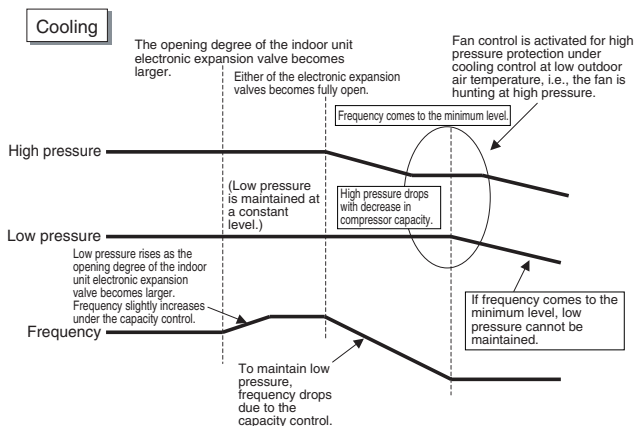

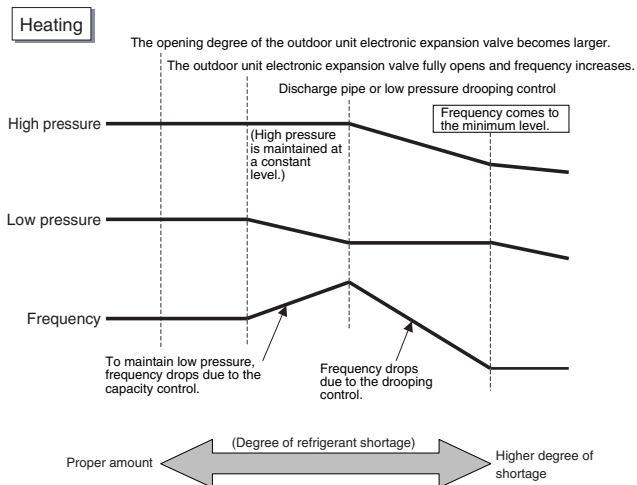

## **CHECK 8** **Vacuuming and dehydration** **procedure**

Conduct vacuuming and dehydration in the piping system following the procedure for <Normal vacuuming and dehydration> described below.

Furthermore, if moisture may get mixed in the piping system, follow the procedure for <Special vacuuming and dehydration> described below.

### **<Normal vacuuming and dehydration>**

#### (1) Vacuuming and dehydration

- Use a vacuum pump that enables vacuuming up to -100.7kPa (5 torr, -755 mmHg).
- Connect manifold gauges to the service ports of liquid pipe and gas pipe and run the vacuum pump for a period of two or more hours to conduct evacuation to -100.7kPa or less.
- If the degree of vacuum does not reach -100.7kPa or less even though evacuation is conducted for a period of two hours, moisture will have entered the system or refrigerant leakage will have been caused. In this case, conduct evacuation for a period of another one hour.
- If the degree of vacuum does not reach -100.7kPa or less even though evacuation is conducted for a period of three hours, conduct the leak tests.

#### (2) Leaving in vacuum state

- Leave the compressor at the degree of vacuum of -100.7kPa or less for a period of one hour or more, and then check to be sure that the vacuum gauge reading does not rise. (If the reading rises, moisture may have remained in the system or refrigerant leakage may have been caused.)

#### (3) Additional refrigerant charge

- Purge air from the manifold gauge connection hoses, and then charge a necessary amount of refrigerant.



**<Special vacuuming and dehydration>** - In case of moisture may get mixed in the piping\*

- (1) Vacuuming and dehydration
  - Follow the same procedure as that for 1) Normal vacuuming and dehydration described above.
- (2) Vacuum break
  - Pressurize with nitrogen gas up to 0.05MPa.
- (3) Vacuuming and dehydration
  - Conduct vacuuming and dehydration for a period of one hour or more. If the degree of vacuum does not reach -100.7kPa or less even though evacuation is conducted for a period of two hours or more, repeat vacuum break - vacuuming and dehydration.
- (4) Leaving in vacuum state
  - Leave the compressor at the degree of vacuum of -100.7kPa or less for a period of one hour or more, and then check to be sure that the vacuum gauge reading does not rise.
- (5) Additional refrigerant charge
  - Purge air from the manifold gauge connection hoses, and then charge a necessary amount of refrigerant.

**i** **Note:**

- \* In case of construction during rainy reason, if dew condensation occurs in the piping due to extended construction period, or rainwater or else may enter the piping during construction work:

**CHECK 9 List of inverter-related error codes**

	Code	Name	Condition for determining error	Major cause
Compressor current	U5	Instantaneous overcurrent of inverter compressor	<ul style="list-style-type: none"> <li>Inverter output current exceeds 32.3A even instantaneously.</li> </ul>	<ul style="list-style-type: none"> <li>Liquid sealing</li> <li>Defective compressor</li> <li>Defective inverter PCB</li> </ul>
	U8	Overcurrent of inverter compressor (Electronic thermal)	<ul style="list-style-type: none"> <li>Compressor overload running</li> </ul> An overcurrent of 19.0A or more continues for a period of 5 consecutive seconds or that of 16.1A or more continues for a period of 260 consecutive seconds. For 230V units: A current of 33.5A or more continues for a period of consecutive 5 sec. or that of 27.6A or more continues for a period of consecutive 260 sec. <ul style="list-style-type: none"> <li>The inverter loses synchronization.</li> </ul>	<ul style="list-style-type: none"> <li>Back-flow of compressor liquid</li> <li>Sudden changes in loads</li> <li>Disconnected compressor wiring</li> <li>Defective inverter PCB</li> </ul>

	Code	Name	Condition for determining error	Major cause
Protection device and others	U1	Defective inverter PCB	<ul style="list-style-type: none"> <li>No output is given.</li> </ul>	<ul style="list-style-type: none"> <li>Defective heavy current part of compressor</li> </ul>
	U9	Defective startup of inverter compressor	<ul style="list-style-type: none"> <li>The compressor motor fails to start up.</li> </ul>	<ul style="list-style-type: none"> <li>Liquid sealing or defective compressor</li> <li>Excessive oil or refrigerant</li> <li>Defective inverter PCB</li> </ul>
	E5	Inverter compressor lock	<ul style="list-style-type: none"> <li>The compressor is in the locked status (does not rotate).</li> </ul>	<ul style="list-style-type: none"> <li>Defective compressor</li> </ul>
	U4	Radiation fin temperature rise	<ul style="list-style-type: none"> <li>The radiation fin temperature reaches 87°C or more (while in operation).</li> </ul>	<ul style="list-style-type: none"> <li>Defective fan</li> <li>Running in overload for an extended period of time</li> <li>Defective inverter PCB</li> </ul>
	U2	Power supply voltage error	<ul style="list-style-type: none"> <li>The inverter power supply voltage is high or low.</li> </ul>	<ul style="list-style-type: none"> <li>Power supply error</li> <li>Defective inverter PCB</li> </ul>
	P1	Imbalanced power supply	<ul style="list-style-type: none"> <li>Power supply voltages get significantly imbalanced among three phases.</li> </ul>	<ul style="list-style-type: none"> <li>Power supply error (imbalanced voltages of 2% or more)</li> <li>Defective inverter PCB</li> <li>Dead inverter PCB</li> </ul>
	U1	Transmission error (between inverter PCB and service monitor PCB)	<ul style="list-style-type: none"> <li>With the outdoor unit PCB, no communications are carried out across service monitor PCB - inverter PCB - fan PCB.</li> </ul>	<ul style="list-style-type: none"> <li>Broken wire in communication line</li> <li>Defective service monitor PCB</li> <li>Defective inverter PCB</li> <li>Defective fan PCB</li> </ul>
	PJ	PCB mismatching	<ul style="list-style-type: none"> <li>Any PCB of specification different from that of the product is connected.</li> </ul>	<ul style="list-style-type: none"> <li>PCB of different specification mounted</li> </ul>
	P4	Defective radiation fin	<ul style="list-style-type: none"> <li>The radiation fin thermistor gets short</li> </ul>	<ul style="list-style-type: none"> <li>Defective radiation fin</li> </ul>

## CHECK 10 Concept of inverter-related error codes

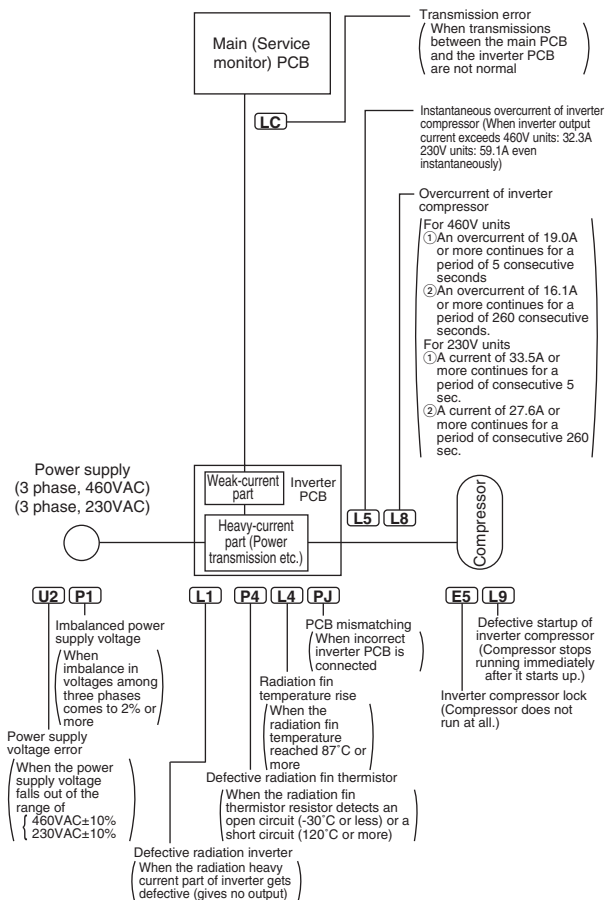

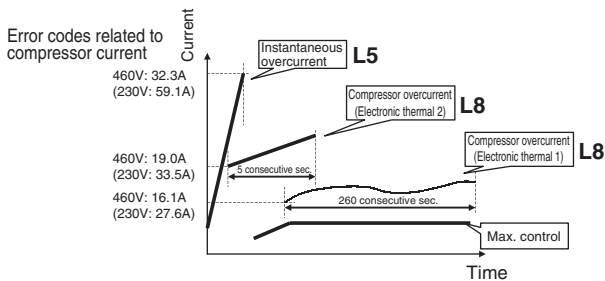

## **CHECK 11** Thermistor Resistance / Temperature Characteristics

### For radiation fin thermistor

T°C	kΩ
-30	354.1
-25	259.7
-20	192.6
-15	144.2
-10	109.1
-5	83.25
0	64.10
5	49.70
10	38.85
15	30.61
20	24.29
25	19.41
30	15.61
35	12.64
40	10.30
45	8.439
50	6.954

T°C	kΩ
55	5.761
60	4.797
65	4.014
70	3.375
75	2.851
80	2.418
85	2.060
90	1.762
95	1.513
100	1.304
105	1.128
110	0.9790
115	0.8527
120	0.7450
125	0.6530
130	0.5741

3PA61998L (AD92A057)

**For outdoor air thermistor**

**For suction pipe thermistor**

**For heat exchanger thermistor**

**For intermediate heat exchanger thermistor**

**For liquid thermistor**

**For remote controller thermistor**

T°C	kΩ
-30	361.7719
-25	265.4704
-20	196.9198
-15	147.5687
-10	111.6578
-5	85.2610
0	65.6705
5	50.9947
10	39.9149
15	31.4796
20	25.0060
25	20.0000
30	16.1008
35	13.0426

T°C	kΩ
40	10.6281
45	8.7097
50	7.1764
55	5.9407
60	4.9439
65	4.1352
70	3.4757
75	2.9349
80	2.4894
85	2.1205
90	1.8138
95	1.5575
100	1.3425
105	1.1614

3SA48001 (AD87A001J)

### For discharge pipe thermistor

T°C	kΩ
-30	3257.371
-25	2429.222
-20	1827.883
-15	1387.099
-10	1061.098
-5	817.9329
0	635.0831
5	496.5712
10	391.0070
15	309.9511
20	247.2696
25	198.4674
30	160.2244
35	130.0697
40	106.1517
45	87.0725
50	71.7703
55	59.4735
60	49.5180

T°C	kΩ
65	41.4168
70	34.7923
75	29.3499
80	24.8586
85	21.1360
90	18.0377
95	15.4487
100	13.2768
105	11.4395
110	9.8902
115	8.5788
120	7.4650
125	6.5156
130	5.7038
135	5.0073
140	4.4080
145	3.8907
150	3.4429

3SA48006 (AD87A001J)



## CHECK 12 Pressure Sensor

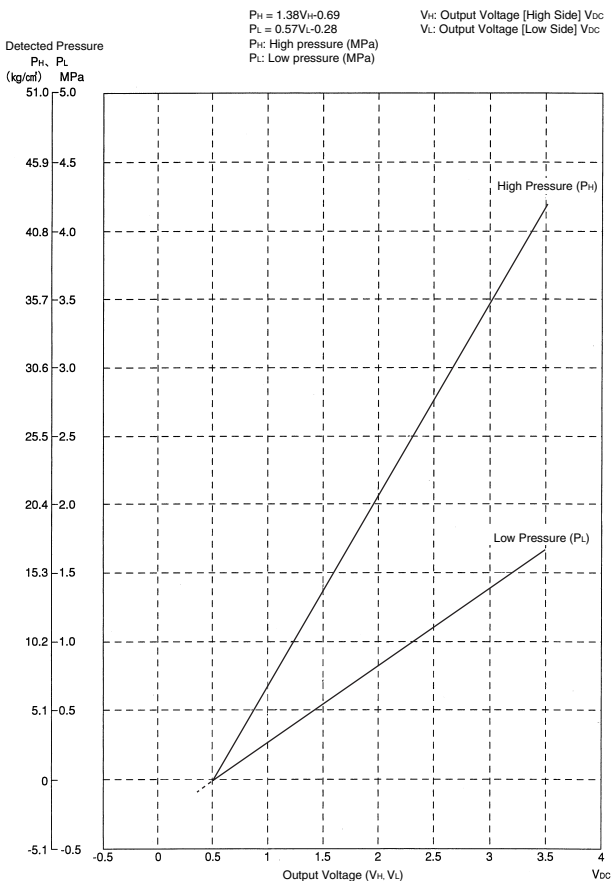

## **CHECK 13** Broken Wire Check of the Connecting Wires

1. Procedure for checking outdoor-outdoor unit transmission wiring for broken wires

On the system shown below, turn OFF the power supply to all equipment, short circuit between the outdoor-outdoor unit terminal F1 and F2 in the "Outdoor Unit A" that is farthest from the centralized remote controller, and then conduct continuity checks between the transmission wiring terminal blocks F1 and F2 of the centralized remote controller using a multiple meter. If there is continuity between the said terminal blocks, the outdoor-outdoor unit transmission wiring has no broken wires in it.

If there is no continuity, the transmission wiring may have broken wires. With the outdoor-outdoor unit terminal of the "Outdoor Unit A" short circuited, conduct continuity checks between the transmission wiring terminal blocks F1 and F2 of the unified ON/OFF controller. If there is no continuity as well, conduct continuity checks between the outdoor-outdoor unit terminal of the "Outdoor Unit E", between the outdoor-outdoor unit terminal of the "Outdoor Unit D", between the outdoor-outdoor unit terminal of the "Outdoor Unit C", ... in the order described, thus identifying the place with continuity.

If the place with continuity can be identified, there may be broken wires in places before the said place with continuity.

2. Procedure for checking indoor-outdoor unit transmission wiring for broken wires (for checking the indoor-outdoor unit transmission wiring of the "Outdoor Unit C" for broken wires)

Turn OFF the power supply to all equipment, short circuit between the indoor-outdoor unit terminal F1 and F2 in the "Outdoor Unit C", and then conduct continuity checks between the transmission wirings F1

"Outdoor Unit C" using a multiple meter. If there is continuity between the said transmission wirings, the indoor-outdoor unit transmission wiring has no broken wires in it.

If there is no continuity, the transmission wiring may have broken wires. With the indoor-outdoor unit terminal of the "Outdoor Unit C" short circuited, identify the place with continuity in the transmission wiring of the "Indoor Unit b", transmission wiring of the "Indoor Unit c", and transmission wiring of the "Indoor Unit d" in the order described.

If the place with continuity can be identified, there may be broken wires in places before the said place with continuity.

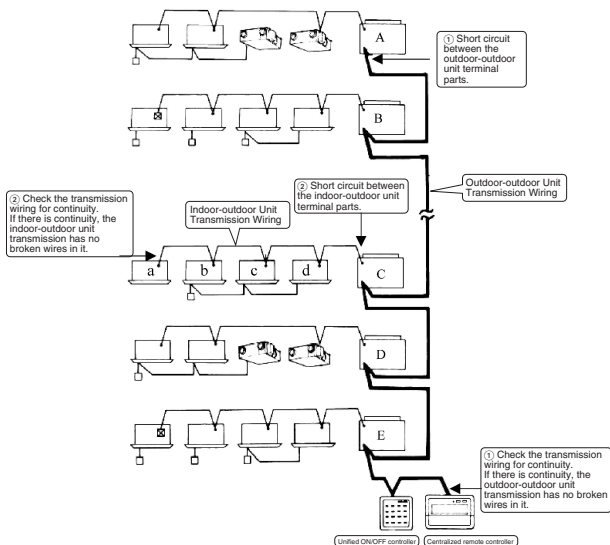

## CHECK 14 Master Unit Centralized Connector Setting Table

The master unit centralized setting connector (CN1/X1A) is mounted at the factory.

- To independently use a single unit of the intelligent Touch Controller or a single unit of the centralized remote controller, do not dismount the master unit centralized setting connector (i.e., use the connector with the factory setting unchanged).
- To independently use the schedule timer, insert an independent-use setting connector.

No independent-use setting connector has been mounted at the factory. Insert the connector, which is attached to the casing of the master unit, in the PCB (CN1/X1A).

(Independent-use connector = Master unit centralized setting connector)

- To use two or more centralized controller in combination, make settings according to the table shown below.

Pattern	Centralized controller connection pattern				Setting of master unit centralized setting connector (*2)			
	intelligent Touch Controller	Centralized remote controller	Unified ON/OFF controller	Schedule timer	intelligent Touch Controller	Centralized remote controller	Unified ON/OFF controller	Schedule timer
(1)	1 to 2 units	/	/	× (*1)	Only a single unit: "Provided", Others: "Not provided"	/	/	/
(2)	/	/	/	× (*1)	/	/	/	/
(3)	1 unit	1 unit	/	× (*1)	Provided	Not provided	/	/
(4)	1 to 2 units	/	1 to 8 units	× (*1)	Only a single unit: "Provided", Others: "Not provided"	/	All "Not provided"	/
(5)	/	/	/	/	/	/	/	/
(6)	/	1 to 4 units	/	1 unit	/	Only a single unit: "Provided", Others: "Not provided"	All "Not provided"	Not provided
(7)	/	/	1 to 16 units	/	/	/	/	/
(8)	/	/	/	1 unit	/	/	/	Not provided
(9)	/	/	/	/	/	/	/	/
(10)	/	/	1 to 16 units	1 unit	/	/	Only a single unit: "Provided", Others: "Not provided"	Not provided
(11)	/	/	/	1 unit	/	/	/	Provided



**Note:**

- \*1. The intelligent Touch Controller and the schedule timer are not available for combined use.
- \*2. The intelligent Touch Controller, centralized remote controller, and the unified ON/OFF controller have been set to "Provided with the master unit centralized setting connector" at the factory. The schedule timer has been set to "Not provided with the master unit centralized setting connector" at the factory, which is attached to the casing of the master unit.

## CHECK 15 Master-Slave Unit Setting Table

Combination of intelligent Touch Controller and Centralized Remote Controller



*	#1		#2		#3		#4	
Pattern	1-00~4-15	Master/ Slave	5-00~8-15	Master/ Slave	1-00~4-15	Master/ Slave	5-00~8-15	Master/ Slave
①	CRC	Master	CRC	Master	CRC	Slave	CRC	Slave
②	CRC	Master	—	—	CRC	Slave	—	—
③	intelligent Touch Controller	Master	—	—	intelligent Touch Controller	Slave	—	—
④	CRC	Master	—	—	intelligent Touch Controller	Slave	—	—
⑤	intelligent Touch Controller	Master	—	—	CRC	Slave	—	—
⑥	CRC	Master	—	—	—	—	—	—
⑦	intelligent Touch Controller	Master	—	—	—	—	—	—

### **i** Note:

CRC: Central remote controller <DCS302CA61>

intelligent Touch Controller: <DCS601C51>

\*The patterns marked with “\*” have nothing to do with those described in the list of setting of master unit centralized setting connector.

## **CHECK 16** Check on connector of fan motor (Power supply cable)

- (1) Turn OFF the power supply.

Measure the resistance between phases of U, V, W at the motor side connectors (three-core wire) to check that the values are balanced and there is no short circuiting, while connector or relay connector is disconnected.

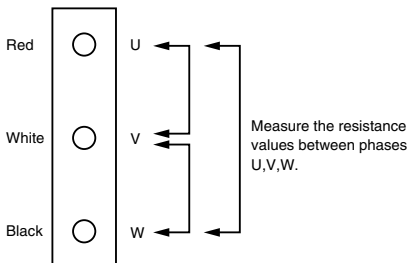

## **CHECK 17** Check on connector of fan motor (Signal cable)

- (1) Turn OFF the power supply.
- (2) Measure the resistance between Vcc and each phase of U, V, W and GND and each phase at the motor side connectors (five-core wire) to check that the values are balanced within the range of  $\pm 20\%$ , while connector or relay connector is disconnected. Furthermore, to use a multiple meter for measurement, connect the probe of negative pole to Vcc and that of positive pole to GND.

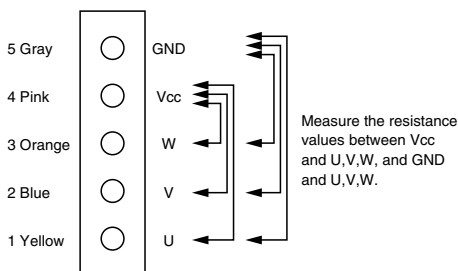



Warning



- Daikin products are manufactured for export to numerous countries throughout the world. Prior to purchase, please confirm with your local authorised importer, distributor and/or retailer whether this product conforms to the applicable standards, and is suitable for use, in the region where the product will be used. This statement does not purport to exclude, restrict or modify the application of any local legislation.
- Ask a qualified installer or contractor to install this product. Do not try to install the product yourself. Improper installation can result in water or refrigerant leakage, electrical shock, fire or explosion.
- Use only those parts and accessories supplied or specified by Daikin. Ask a qualified installer or contractor to install those parts and accessories. Use of unauthorised parts and accessories or improper installation of parts and accessories can result in water or refrigerant leakage, electrical shock, fire or explosion.
- Read the User's Manual carefully before using this product. The User's Manual provides important safety instructions and warnings. Be sure to follow these instructions and warnings.

If you have any enquiries, please contact your local importer, distributor and/or retailer.

### Cautions on product corrosion

1. Air conditioners should not be installed in areas where corrosive gases, such as acid gas or alkaline gas, are produced.
2. If the outdoor unit is to be installed close to the sea shore, direct exposure to the sea breeze should be avoided. If you need to install the outdoor unit close to the sea shore, contact your local distributor.



JMI-0107

Organization:  
DAIKIN INDUSTRIES, LTD.  
AIR CONDITIONING MANUFACTURING DIVISION

Scope of Registration:  
THE DESIGN/DEVELOPMENT AND MANUFACTURE OF  
COMMERCIAL AIR CONDITIONING, HEATING, COOLING,  
REFRIGERATING EQUIPMENT, HEATING EQUIPMENT,  
RESIDENTIAL AIR CONDITIONING EQUIPMENT, HEAT  
RECLAIM VENTILATION, AIR CLEANING EQUIPMENT,  
COMPRESSORS AND VALVES.



JQA-1452

Organization:  
DAIKIN INDUSTRIES  
(THAILAND) LTD.

Scope of Registration:  
THE DESIGN/DEVELOPMENT  
AND MANUFACTURE OF AIR  
CONDITIONERS AND THE  
COMPONENTS INCLUDING  
COMPRESSORS USED FOR



EC99J2044

All of the Daikin Group's business  
facilities and subsidiaries in Japan  
are certified under the ISO 14001  
international standard for  
environment management.

Dealer

**DAIKIN INDUSTRIES, LTD.**

Head Office:  
Umeda Center Bldg., 2-4-12, Nakazaki-Nishi,  
Kita-ku, Osaka, 530-8323 Japan  
Tokyo Office:  
JR Shinagawa East Bldg., 2-18-1, Konan,  
Minato-ku, Tokyo, 108-0075 Japan

Большая библиотека технической документации

<https://splitsystema48.ru/instrukcii-po-ekspluatcii-kondicioner/>

каталоги, инструкции, сервисные мануалы, схемы.